

Alaris® GW Volumetric Pump (with Set Detection Mode disabled)

Directions For Use
en

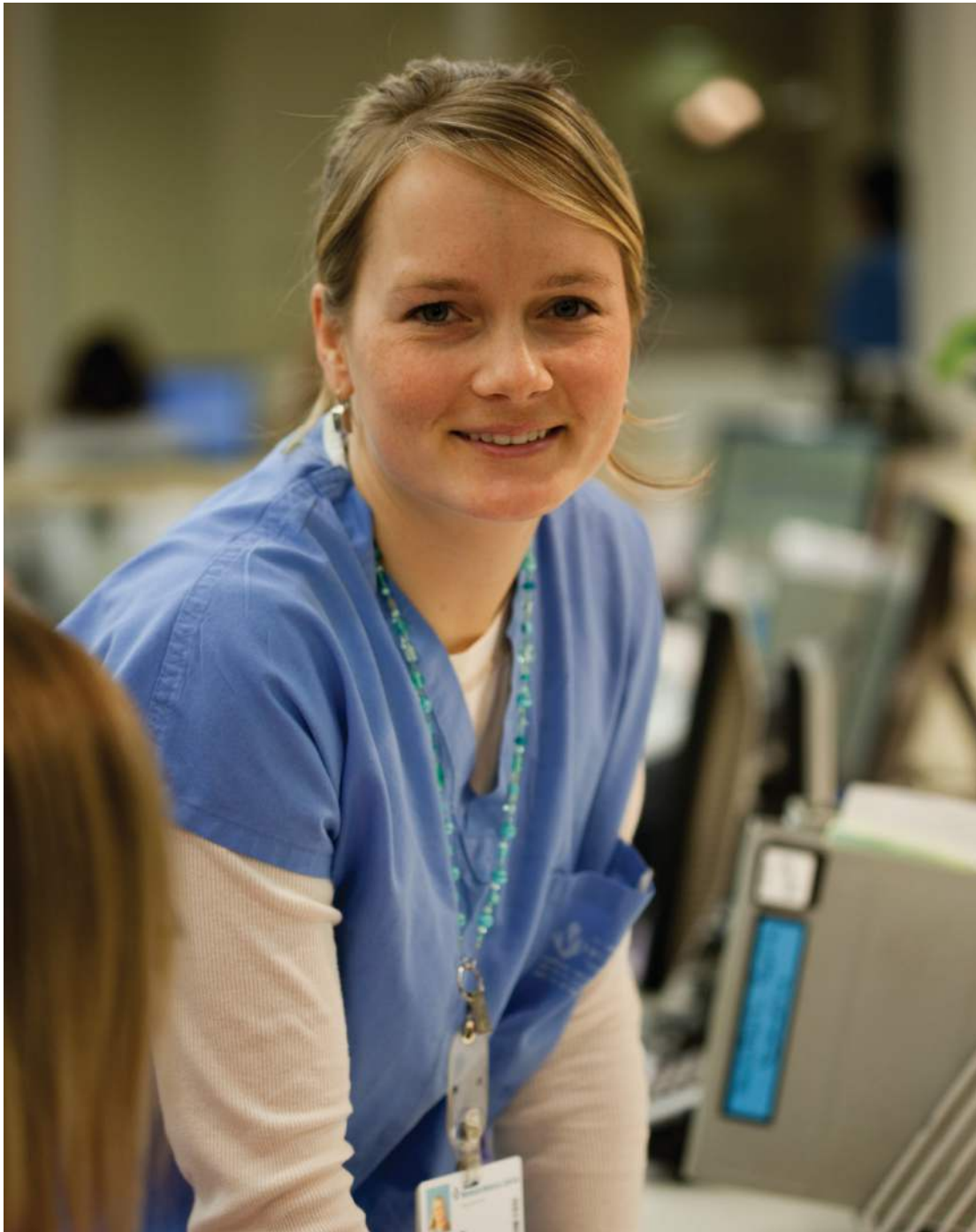

CE
0086

 CareFusion

Contents

	Page
Introduction	2
About This Manual	3
Quick Start Guide	3
Features of the Alaris® GW Volumetric Pump	4
Controls and Indicators.....	5
Symbol Definitions.....	6
Operating Precautions	7
Getting Started	10
Starting the Infusion	14
Secondary / Piggyback Infusions.....	15
Basic Features.....	16
User Selectable Options	19
Configurable Options Sheet	20
Alarms.....	21
Warnings	22
Flow Sensor Operation	23
Compatible Dedicated Infusion Sets	24
Associated Products.....	27
Maintenance.....	28
Cleaning and Storage	29
Specifications.....	30
IrDA, RS232 and Nurse Call Specification	33
Trumpet and Flow Rate Curves	34
Technical Description	35
Products and Spare Parts	36
Service Contacts	37

Introduction

The Alaris® GW Volumetric Pump (herein after referred to as 'Pump') is a small lightweight volumetric infusion pump that provides accurate and reliable infusions over a range of rates.

To achieve the nominal performance stated in this DFU, CareFusion strongly recommends use of Alaris® GW branded dedicated infusion sets. Facilities intending to use non-dedicated infusion sets with the set detection mode disabled are advised to assess performance prior to clinical use. If adequate performance is not achieved, then Alaris® GW branded dedicated infusion sets should be used or the Alaris® GW Volumetric Pump should be re-calibrated. The use of a flow sensor is mandatory when the automatic set detection mode on the pump is disabled.



DISCLAIMER. This pump has been tested and approved by CareFusion for use only with CareFusion dedicated infusion sets. In the event the user is considering using infusion sets, not approved for use with the Alaris® GW Volumetric Pump, the user should consult an authorized CareFusion representative for compatibility and/or calibration information prior to use. In no event, however, does CareFusion make any representations or warranties concerning the adequacy and safe performance of any non-dedicated infusion sets as it relates to the operation of the pump and the accuracy of the infusion.

In no event shall CareFusion be liable for any damages of any kind or nature, including without limitation, direct or indirect, special, consequential, or incidental damages arising from, or in connection with, the use of non-dedicated infusion sets (Infusion sets not manufactured by CareFusion), regardless of whether CareFusion has been advised as to the possibility of such use.

Intended Purpose

The Alaris® GW Volumetric Pump is intended for use by medical staff for the purpose of controlling infusion rate and volume.

Conditions for Use

The Alaris® GW Volumetric Pump should only be operated by medical staff competent in the use of automated volumetric pumps and in the management of infusion therapy. Medical staff should determine the suitability of the device in their care area for its intended purpose.

Indications

The Alaris® GW Volumetric Pump is indicated for the infusion of fluids, medications, parenteral nutrition, blood and blood products through clinically acceptable routes of administration; such as intravenous (IV), intra-arterial (IA), subcutaneous, epidural or irrigation of fluid spaces. The Alaris® GW Volumetric Pump is indicated for use on adults and paediatrics.

Contraindications

The Alaris® GW Volumetric Pump is contraindicated for enteral therapies.

About This Manual

The user must be thoroughly familiar with the pump described in this manual prior to use.

All illustrations used in this manual show typical settings and values which may be used in setting up the functions of the pump.

These settings and values are for illustrative use only. The complete range of settings and values are detailed in the specifications section.



It is important to ensure that you only refer to the most recent version of the Directions for Use and Technical Service Manual for your CareFusion products. These documents are referenced on www.carefusion.com. Copies can be obtained by contacting your local CareFusion representative.

Conventions used in this manual

BOLD	Used for Display names, software commands, controls and indicators referenced in this manual, for example, Battery Indicator, PURGE, ON/OFF button.
'Single quotes'	Used to indicate cross-references made to another section of this manual.
<i>Italics</i>	Used to refer to other documents or manuals and also used for emphasis.
	Important Information: Wherever this symbol is shown an Important note is found. These notes highlight an aspect of use that is important for the user to be aware of when operating the pump.

Quick Start Guide





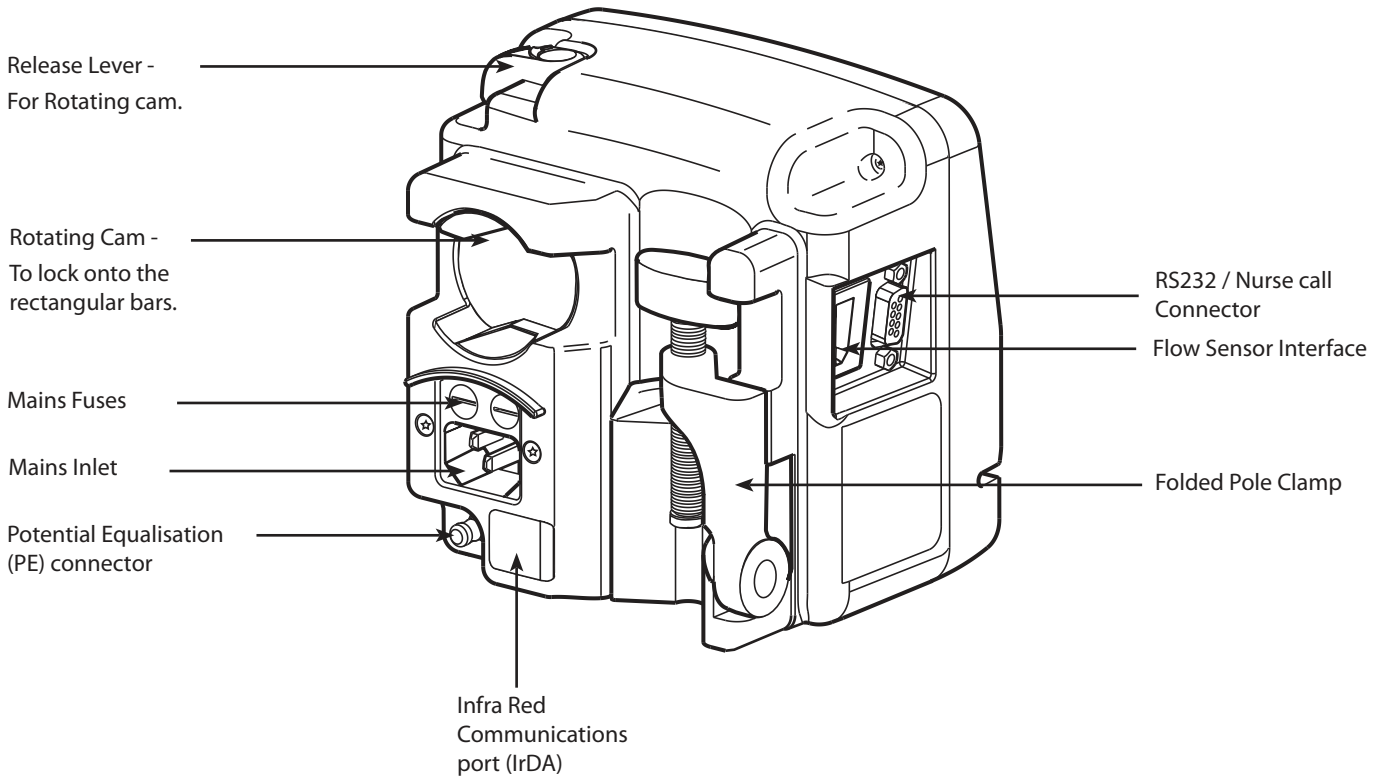
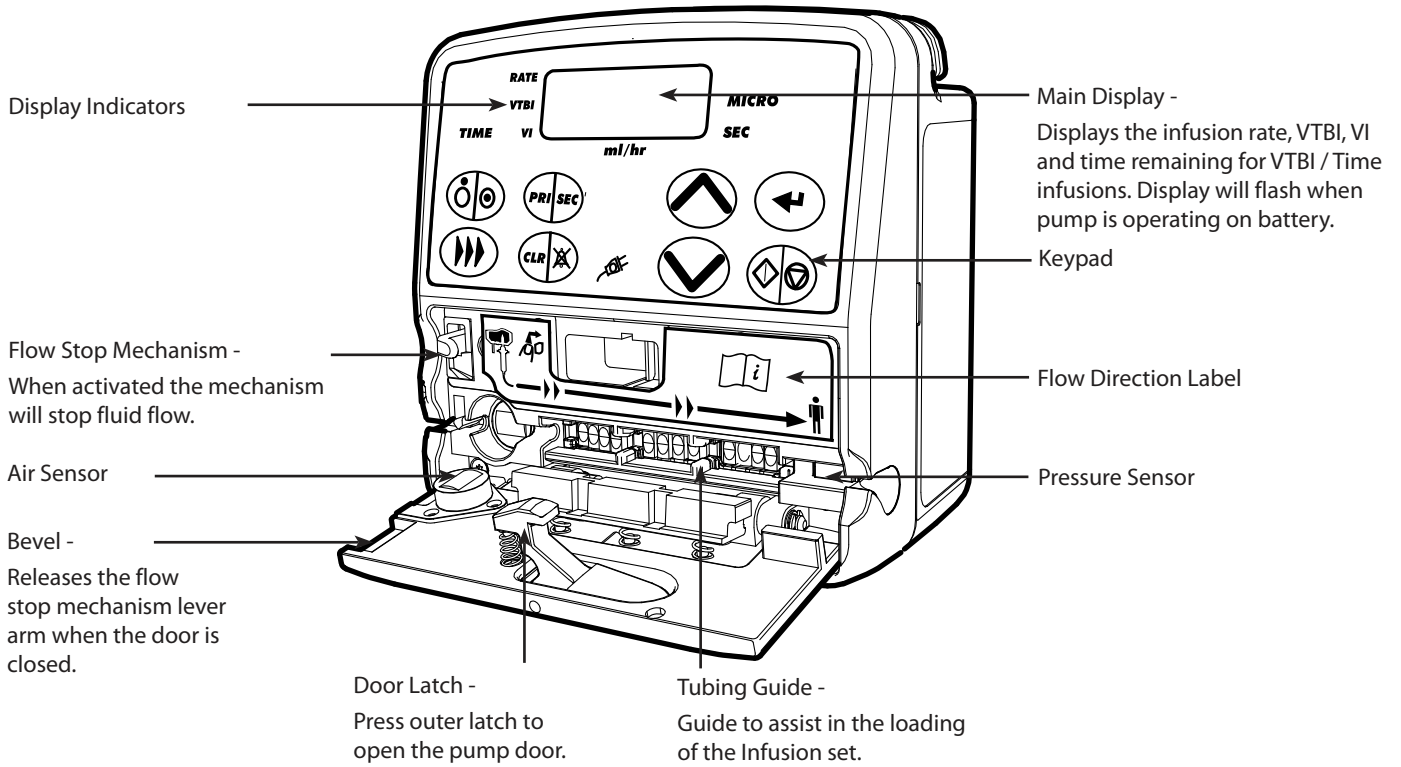

1. Half fill the drip chamber.
2. Press to switch pump on.
3. Load the infusion set and open in-line clamp.
4. Prime (*FILL*) set: Press once. Whilst *FILL* is displayed press again and hold to clear all visible air from the line.
5. Enter rate using / .
6. Press once to confirm and scroll to VTBI.
7. Enter VTBI using / , or switch off VTBI by scrolling until *OFF* is displayed.
8. Press to confirm and scroll to VI.
9. If necessary, press to clear VI.
10. Connect Infusion set to the patient access device.
11. Press to start infusion.

Features of the Alaris® GW Volumetric Pump



Controls and Indicators

Controls















Symbol	Description
	ON/OFF button - Press once to switch the pump ON. Press and hold down for approximately 3 seconds to switch the pump OFF.
	RUN/HOLD button - Press to start the infusion or to put the infusion on hold.
	CLEAR/SILENCE button - Press to silence alarm for 1 minute. The alarm will resound after this time. Resets numeric values to zero.
	PRIME/BOLUS button - Primes the Infusion set. Administers bolus during the infusion.
	PRIMARY/SECONDARY button - Switches the pump between Primary and Secondary infusion modes. (If enabled).
	ENTER button - Scrolls between rate, time, VTBI and total volume infused (VI). Enters values for selected infusion / configuration parameters. Confirms the rate during an infusion titration.
	CHEVRON keys - Increases or decreases the infusion rate, TIME limit and VTBI. Press and hold to increase the selection speed. Used to adjust user selectable options

Indicators: (when illuminated)

Symbol	Description
	AC POWER indicator - When illuminated the pump is connected to an AC power supply.
RATE	The pump is displaying the infusion rate in millilitres per hour (ml/h).
VTBI	The pump is displaying the Volume To Be Infused (VTBI) in millilitres (ml).
VI	The pump is displaying the Volume Infused (VI) in millilitres (ml).
TIME	The pump is displaying the infusion time in hours : mins.
MICRO	The pump is operating in the MICRO Mode. When not illuminated the pump is in the STANDARD Mode.
SEC	The pump is operating in the SECONDARY Mode. When not illuminated the pump is in the PRIMARY Mode.
ml/hr	(Millilitres / hour) When ml is illuminated the pump displays the rate, VTBI or VI. When the hr is illuminated the pump displays the rate or infusion time.

Symbol Definitions

Labelling Symbols:

Symbol	Description
	Attention Consult accompanying documents
	Potential Equalisation (PE) Connector
	RS232/Nursecall Connector.
	Type CF applied part. (Degree of protection against electrical shock)
IPX1	Protected against vertically falling drops of water
	Alternating Current
	Device complies with the requirements of Council Directive 93/42/EEC as amended by 2007/47/EC.
	Date of Manufacture
	Manufacturer
	Connector for Flow Sensor
	Not for Municipal Waste
	Fuse rating
	Authorised representative in the European Community
	Infusion indicator - Displays fluid drops detected by the flow sensor when infusing at a normal rate.
	Infusion indicator - Displays fluid drops detected by the flow sensor when infusing in MICRO mode.

Operating Precautions

Infusion Sets

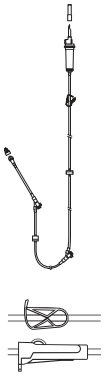

- To ensure correct and accurate operation, only use CareFusion single use infusion sets described in the 'Compatible Dedicated Infusion Sets' section of this Directions for Use. Use an infusion set with an anti-siphon valve whenever possible. The anti-siphon valve prevents free flow from occurring if an infusion set is incorrectly loaded or removed from the pump.
- It is recommended that Infusion sets are changed in accordance with the Directions for Use. Carefully read the Directions For Use supplied with the Infusion set prior to use. Use of non-specified Infusion sets may impair the operation of the pump and the accuracy of the infusion.
- When combining several apparatus and/or instruments with Infusion sets and other tubing, for example via a 3-way tap or multiple Infusion, the performance of the pump may be affected and should be monitored closely.
- Uncontrolled flow may result if the Infusion set is not properly isolated from the patient i.e. closing a tap in the set or activating an in-line clamp/roller clamp.
- The Infusion set may be fitted with an in-line clamp, which can be used to occlude tubing in case it is required to stop fluid flow.
- The Alaris® GW Volumetric Pump is a positive pressure pump, which should use Infusion sets fitted with Luer lock fittings or equivalent locking connectors.
- To infuse from a burette, close the roller clamp above the burette and open the clamp on the vent on top of the burette.
- Discard Infusion set if the packaging is not intact or the protector cap is detached. Ensure sets are not kinked as this may occlude the tubing.
- CareFusion recommends the use of the IVAC® Model 180 Flow Sensor when using sets without anti-siphon valves or the mandatory use of the IVAC® Model 180 Flow Sensor whenever the pump set detection mode is disabled. The flow sensor automatically monitors the infusion flow rate through the drip chamber and will cause the pump to alarm if a significant deviation from the infusion rate occurs. The flow sensor will detect empty containers.

Mounting the Pump

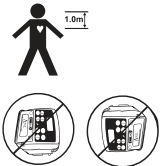

- The fluid height in the container must not be more than 1 metre above the patients heart.
- Do not mount the pump in a vertical position with the AC power inlet pointing upwards as this could affect electrical safety, in the event of a fluid spill over the pump.

Operating Pressure

- The pumping pressure alarm system is not designed to provide protection against, or detection of, IV complications which can occur.

Alarm Conditions



- Several alarm conditions detected by this pump will stop the infusion and generate visual and audible alarms. Users must perform regular checks to ensure that the infusion is progressing correctly and no alarms are operating.

Using Collapsible bags, Glass Bottles & Semi Rigid containers

- It is recommended that the air vent be opened on the Alaris® GW Volumetric Pump set if using glass bottles or semi-rigid containers, to reduce the partial vacuum formed as the fluid is infused from the container. This action will ensure the pump can maintain volumetric accuracy whilst the container empties. The action of opening the air vent for semi-rigid containers should take place after the spiking of the container and priming of the drip chamber.

Steps for the Collapsible bags

Follow steps 1 to 3 as shown for the semi-rigid containers, however do not open vent as in step 4, but prime the set as per step 5. Ensure the bag outlet is fully pierced before filling the drip chamber.

Steps for Semi-rigid containers

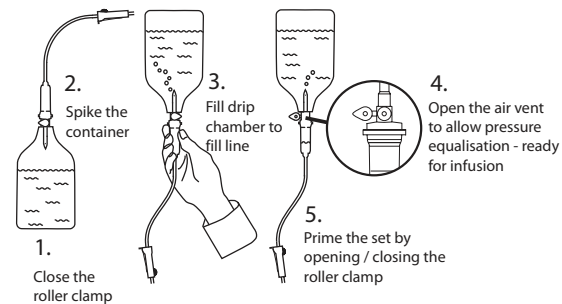

Operating Environment

- When using any infusion pump in conjunction with other pumps or devices requiring vascular access, extra care is advised. Adverse delivery of medication or fluids can be caused by the substantial variation in pressures created within the local vascular system by such pumps. Typical examples of those pumps are used during dialysis, bypass or cardiac assist applications.
- This pump is suitable for use in Hospital and clinical environments other than domestic establishments and those directly connected to the public single phase AC mains power supply network that supplies buildings used for domestic purposes. However, it may be used in domestic establishments under the supervision of Medical professionals with additional necessary appropriate measures. (Consult Technical Service Manual, appropriately trained qualified service personnel or CareFusion for further information).
- This pump is not intended to be used in the presence of a flammable anaesthetic mixture with air or oxygen or nitrous oxide.
- Align all Alaris® GW Volumetric Pumps within a particular hospital or clinical environment to the same automatic set detection mode (ie. All **On** or all **OFF**) to avoid potential confusion amongst users as to the mode in which the pump is operating under and hence to ensure that the appropriate recommendations for flow sensor usage are followed.

Earth Conductor



- The Alaris® GW Volumetric Pump is a Class I device, therefore must be earthed when connected to an AC power supply.
- This pump also has an internal power source.
- When connected to an external power source, a three-wire (Live, Neutral, Earth) supply must be used. If the integrity of the external protective conductor on the AC power cable has been compromised, the pump should be disconnected from the AC power source and operated utilising the internal battery.

Electromagnetic Compatibility and Interference



- This pump is protected against the effects of external interference, including high energy radio frequency emissions, magnetic fields and electrostatic discharge (for example, as generated by electrosurgical and cauterising equipment, large motors, portable radios, cellular telephones etc.) and is designed to remain safe when unreasonable levels of interference are encountered.
- Therapeutic Radiation Equipment: Do not use the pump in the vicinity of any Therapeutic Radiation Equipment. Levels of radiation generated by the radiation therapy equipment such as Linear Accelerator, may severely affect functioning of the pump. Please consult manufacturer's recommendations for safe distance and other precautionary requirements. For further information, please contact your local CareFusion representative.
- Magnetic Resonance Imaging (MRI): The pump contains ferromagnetic materials which are susceptible to interference with magnetic field generated by the MRI devices. Therefore, the pump is not considered an MRI compatible pump as such. If use of the pump within an MRI environment is unavoidable, then CareFusion highly recommends securing the pump at a safe distance from the magnetic field outside the identified Controlled Access Area in order to evade any magnetic interference to the pump; or MRI image distortion. This safe distance should be established in accordance with the manufacturers' recommendations regarding electromagnetic interference (EMI). For further information, please refer to the product technical service manual (TSM). Alternatively, contact your local CareFusion representative for further guidance.
- Accessories: Do not use any non-recommended accessory with the pump. The pump is tested and compliant with the relevant EMC claims only with the recommended accessories. Use of any accessory, transducer or cable other than those specified by CareFusion may result in increased emissions or decreased pump immunity.
- In some circumstances the pump may be affected by an electrostatic discharge through air at levels close to or above 15kv; or by radio frequency radiation close to or above 10v/m. If the pump is affected by this external interference the pump will remain in a safe mode; the pump will duly stop the infusion and alert the user by generating a combination of visual and audible alarms. Should any encountered alarm condition persist even after user intervention, it is recommended to replace that particular pump and quarantine the pump for the attention of appropriately trained qualified service personnel.
- This pump is a CISPR 11 Group 1 Class B device and uses RF energy only for its internal function in the normal product offering. Therefore, its RF emissions are very low and are not likely to cause any interference with the nearby electronic equipment. However, this pump emits a certain level of electromagnetic radiation which is within the levels specified by IEC/EN60601-1-2 and IEC/EN60601-2-24. If the pump interacts with other equipment, measures should be taken to minimise the effects, for instance by repositioning or relocation.
- For further information on electromagnetic compatibility, please consult Technical Service Manual, 1000SM00006.



Hazards



- An explosion hazard exists if the pump is used in the presence of flammable anaesthetics. Exercise care to locate the pump away from any such hazardous sources.



- A fire hazard may exist if the pump is used in the presence of high oxygen concentrations.



- Dangerous Voltage: An electrical shock hazard exists if the pump's casing is opened or removed. Refer all servicing to qualified service personnel.
- Electrostatic discharge (ESD) precautions are required when connecting RS232/Nurse Call. Touching the pins of the connectors may result in ESD protection failure. It is recommended that all actions must be taken by appropriately qualified service personnel.



- If this pump is dropped, subjected to excessive moisture, fluid spillage, humidity or high temperature, or otherwise suspected to have been damaged, remove it from service for inspection by qualified service personnel. When transporting or storing the pump, use original packaging where possible, and adhere to temperature, humidity and pressure ranges stated in the Specifications section and on the outer packaging.
- Warning: Alaris® GW Volumetric Pumps should not be modified or altered in any way, except where explicitly directed or authorised by CareFusion. Any use of Alaris® GW Volumetric Pumps which have been altered or modified otherwise than in strict application of directions provided by CareFusion, is at your sole risk, and CareFusion does not provide any warranty for or endorsement on any Alaris® GW Volumetric Pump that has been so modified or altered. CareFusion's product warranty shall not apply in the event the Alaris® GW Volumetric Pump has suffered damage or premature wear, or malfunctions or otherwise operates incorrectly, as a result of unauthorised modification or alteration of the Alaris® GW Volumetric Pump.

Getting Started



Before operating the pump read this Directions For Use (DFU) manual carefully.

Initial Set Up

1. Check that the pump is complete, undamaged and that the voltage rating specified on the label is compatible with your AC power supply.
2. Items supplied are :
 - Alaris® GW Volumetric Pump
 - User Support CD (Directions For Use)
 - AC Power Cable (as requested)
 - Protective Packaging
 - Model 180 Flow Sensor (Pump model dependent, if not supplied then the flow sensor can be ordered separately)
3. Connect the pump to the AC power supply for at least 2½ hours to ensure that the internal battery is charged (verify that the  is lit).



The pump will automatically operate from its internal battery if the pump is switched on without being connected to the power supply.

Should the pump fail to perform correctly, replace in its original protective packaging, where possible and contact qualified service personnel for investigation.

4. Facilities intending to use non-dedicated infusion sets with the Set Detection Mode disabled are advised to assess performance of the pump and infusion set combination prior to clinical use. If adequate performance is not achieved, then the Alaris® GW branded dedicated infusion sets should be used or the pump should be recalibrated by following the volumetric calibration procedure described in the Technical Service Manual Addendum 1000SM00014.



Factory set calibration values in the Alaris® GW Volumetric Pump are intended specifically to support the use of Alaris® GW branded dedicated infusion sets. Compatibility of factory calibration settings with Alaris® GW branded dedicated infusion sets is controlled by CareFusion.

CareFusion reserves the right to make changes to the Alaris® GW Volumetric Pump without notice which may affect its performance with non-dedicated infusion sets. If adequate performance is not achieved, then Alaris® GW branded dedicated infusion sets should be used or the Alaris® GW Volumetric pump should be re-calibrated.

It is recommended that the performance of any non-dedicated infusion set is re-evaluated periodically as the set manufacturer may change specifications significant to the performance of the Alaris® GW Volumetric Pump without notice.

Pole Clamp Installation

A pole clamp is fitted to the rear of the pump and will provide secure fixing to vertical I.V. poles of a diameter between 15 and 40 mm.

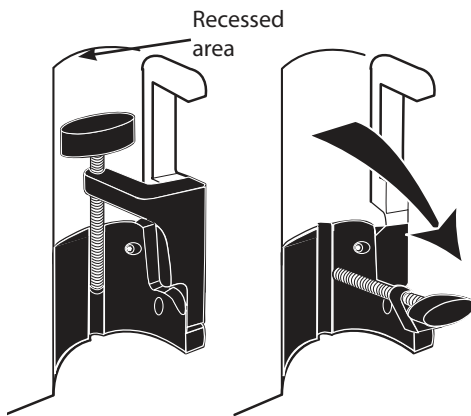

1. Pull the folded pole clamp towards you and unscrew the clamp to leave enough room for the size of the pole.
2. Place pump around pole and tighten screw until the clamp is secured to the pole.



Never mount the pump such that the Infusion stand becomes top heavy or unstable.

Ensure pole clamp is folded away and stored within recessed area at the rear of the pump before connecting to a Docking Station/Workstation* or when not in use.



Prior to each use, check the pole clamp:

- does not show any signs of excessive wear,
- does not show any signs of excessively loose movement in the extended, mountable position.

If these signs are observed, the pumps should be taken out of service for examination by qualified service personnel.

Docking Station/Workstation* or Equipment Rail Installation

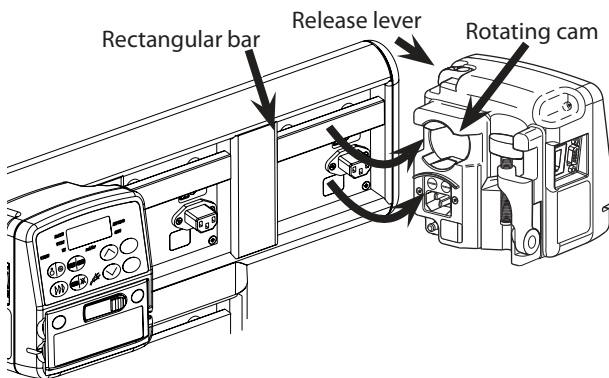

The rotating cam can be fitted to the rectangular bar on the Docking Station/Workstation* or equipment rails measuring 10mm by 25mm.

1. Align the rotating cam on the rear of the pump with the rectangular bar on the Docking Station/Workstation* or the equipment rail.
2. Push the pump firmly onto the rectangular bar or equipment rail.
3. Ensure that the pump 'clicks' securely into position onto the rail or bar.
4. To release, push the release lever and pull the pump forwards.



It is recommended that infusion bags be located on a hanger directly above the pump with which they are being used. This minimises the potential for confusion of Infusion sets when multiple volumetric pumps are used.

*Alaris® DS Docking Station and Alaris® Gateway Workstation.

Loading an Infusion Set



Ensure the appropriate Infusion set for the fluid/drug to be infused has been selected.

Follow the instructions supplied with the individual Infusion set.

Use of non-specified Infusion sets may impair the operation of the pump and the accuracy of the infusion. For Alaris® GW Volumetric Pump Infusion sets refer to 'Infusion Sets' section of the DFU.

Position the IV fluid container to avoid spillage onto the pump.

Ensure that the tubing is inserted completely into the pumping channel, avoiding any slack.

When using 273-003, 273-003V, 273-303E and 273-303EV Infusion sets, ensure a separation of at least 50cm is maintained between the pump and the upper Back Check Valve.

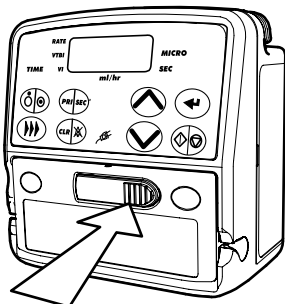

1. Close the in-line clamp on the Infusion set. Press the door latch to open the tubing cover door.

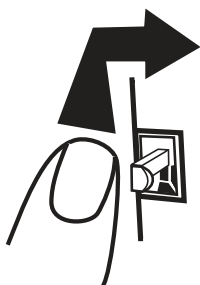

2. Release the flow stop mechanism by pushing the lever arm up and to the right.

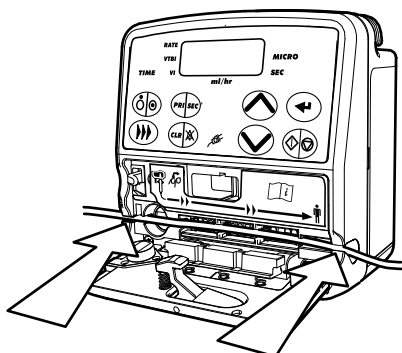

3. Avoiding any slack, insert the infusion set from left to right into the slot provided, following the flow direction label. Make sure that the infusion set is pressed firmly past the constriction points and into the slots on either side of the casing.

4. Re-engage the flow stop mechanism by pushing the lever left and down.

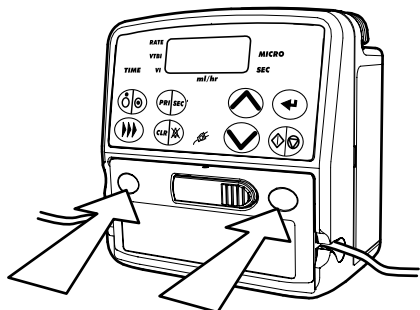

5. Close the tubing cover door. Use the recesses in the cover door to press the door firmly to ensure the latch is correctly applied. Open in-line clamp on the Infusion set.



6. Observe fluid chamber and check for no fluid flow.

Power On/Off

To power up the pump:

1. Press the  button once and release.
2. Check:
 - A high pitch sounder is activated for 3 seconds during this time the main speaker 'beeps' once upon power up sequence.
 - All display segments and all indicators are lit.
 - If an error occurs during self-test the pump will alarm.
3. After this self-test the pump will display last rate setting entered or zero, depending on the configuration.

To power down the pump:

1. Press and hold . The pump will display OFF3-OFF2-OFF1.
2. If the  button is released during the countdown the pump will not power down and it will return to its previous state.





If the pump alarms, segments / indicators do not light up correctly or 2 audible sounds are not heard, then the pump must be powered down immediately, and qualified service personnel contacted. If transportation to an engineer is necessary, it is recommended to use the original protective packaging.

Priming the Infusion Set



Use an infusion set with an anti-siphon valve whenever possible. The anti-siphon valve prevents free flow from occurring if an infusion set is incorrectly loaded or removed from the pump. Infusion sets with an anti-siphon valve can only be primed when loaded in the pump.

When using infusion sets without an anti-siphon valve eg. 273-004, 273-007 and 273-008, the infusion set can be primed without using the pump. Use of a flow sensor is recommended when using an infusion set without an anti-siphon valve. The flow sensor will cause the pump to alarm if a significant deviation from the set infusion rate occurs.

1. Ensure the pump is switched on and in-line clamp is open.
2. Load the Infusion set (see 'Loading the Infusion Set').
3. Press  button once *FILL* will be displayed.
4. Press and Hold  button while *FILL* is still displayed, prime the Infusion set until there is no visible air in the IV line (according to hospital protocol).
5. Attach the set to the patient or other Infusion set.
6. Start the infusion (see 'Starting the Infusion').



Use the prime function to fill the Infusion sets before starting an infusion.

Never connect the Infusion set to the patient during the priming process.

The prime (*FILL*) volume delivered will not be subtracted from the VTBI, or added to the total volume infused.

Automatic Set Detection

When using a compatible dedicated CareFusion infusion set (refer to 'Compatible Dedicated Infusion Sets' section), it is recommended that the set detection mode is enabled on the Alaris® GW Volumetric Pump. This mode can be enabled in Technician Mode on the pump (refer to the Technical Service Manual addendum 1000SM00014 for more details).

Align all Alaris® GW Volumetric Pumps within a particular hospital or clinical environment to the same automatic set detection mode (ie. All **On** or all **OFF**). This will help to avoid potential confusion amongst users as to the mode in which the pump is operating under and hence to ensure that the appropriate recommendations for flow sensor usage are followed.

When the automatic set detection is set to **On**, the pump automatically tests that a compatible CareFusion Infusion set has been loaded correctly (refer to 'Compatible Dedicated Infusion Sets' section). The test will occur at the start of the first infusion after the pump is switched on or after the door has been opened; the pump will run in reverse for 10 seconds and then forward for 10 seconds, the test takes a maximum of 20 seconds to complete. During this operation the clinician may observe a blood return that will be more evident if using a small catheter.

If the pump fails to detect a correct CareFusion Infusion set or detects a possible set misload, then the pump will alarm and display *bAd SEt* refer to 'Alarms and Warnings' section of this DFU.

Please contact your local CareFusion representative if further information or support is required regarding the Automatic Set Detection operation or the application of this pump in specific clinical settings, e.g. neonatal.

Starting the Infusion

Check:

- The pump is switched on.
- The Infusion set has been primed (refer to 'Priming the Infusion Set' section of this DFU).
- The in-line clamp is open.
- The flow sensor is connected (refer to 'Flow Sensor Operation' section of this DFU).
- $\bar{0}$ indicates a drop is detected by the flow sensor during infusion.

Standard Mode

1. Enter infusion rate using the ∇ \blacktriangle keys.
2. Press \rightarrow button once to confirm the infusion rate.
3. Enter VTBI using the ∇ \blacktriangle keys or switch VTBI off by pressing the ∇ button until **OFF** is displayed.
4. Press \rightarrow button to confirm the VTBI.
5. Press \times to clear VI if required.
6. Press \odot button to start infusing.

Standard Mode with VTBI / Time Infusion on

1. Enter VTBI using the ∇ \blacktriangle keys.
2. Press \rightarrow button once to confirm the VTBI.
3. Enter TIME using the ∇ \blacktriangle keys.
4. Press \rightarrow button to confirm the TIME.
5. Press \times to clear VI if required.
6. Press \odot button to start infusing.

Micro Mode

1. Enter infusion rate using the ∇ \blacktriangle keys.
2. Press \rightarrow button once to confirm the infusion rate.
3. Enter VTBI using the ∇ \blacktriangle keys or switch VTBI off by pressing the ∇ button until **OFF** is displayed.
4. Press \rightarrow button to confirm the VTBI.
5. Press \times to clear VI if required.
6. Press \odot button to start infusing.

Micro Mode with VTBI / Time Infusion on

1. Enter VTBI using the ∇ \blacktriangle keys.
2. Press \rightarrow button once to confirm the VTBI.
3. Enter TIME using the ∇ \blacktriangle keys.
4. Press \rightarrow button to confirm the TIME.
5. Press \times to clear VI if required.
6. Press \odot button to start infusing.

Secondary / Piggyback Infusions

Secondary (or piggyback) Infusion mode is only available if configured, refer to Configurable Options section of this DFU.
Secondary Infusion mode is used to administer an intermittent fluid / drug solution e.g. 4 hourly antibiotic infusion using:

- A primary infusion set with an in-line check valve before the Y-Injection site e.g. 273-003 or 273-303E.
- A secondary infusion set e.g. 72213 or 72213N.



Primary fluid container must hang lower (approximately 20cm lower) than the secondary fluid container to allow the secondary infusion to run. Primary infusion will restart on completion of the secondary infusion.

1. Set the primary infusion, but do not start (refer to 'Starting the Infusion' section of this DFU). If pump is running press button to put pump on hold.
2. Prime Secondary Infusion set, following the instructions supplied.
3. Close the in-line clamp on the secondary set.
4. Connect secondary Infusion set into upper Y-injection site of the primary Infusion set.
5. Lower primary fluid container using extension hook supplied with the secondary Infusion set.
6. Press button and **SEC** will be displayed.

Rate / Volume

Or VTBI / TIME

7. Enter required rate using the keys.
8. Press button to scroll to VTBI.
9. Enter VTBI using the keys.
10. Open the in-line clamp on the secondary set.
11. Press button to scroll further, or press button to start the secondary infusion.
12. Ensure the SEC (Secondary) indicator is lit.

Note: The infusion rate will automatically revert to the primary infusion rate when the secondary infusion is complete. On completion of the primary infusion the pump will continue at Keep Vein Open rate (KVO) rate.



During primary / secondary infusion of 2 drugs into a single lumen line, it is essential to ensure drug / fluid compatibility by consulting a drug compatibility chart or local pharmacist, prior to infusion.

The secondary set connects to the upper Y-connection on the primary Infusion set.

To set the Secondary Infusion the pump must be on *Hold* or not running.

Secondary infusion rates above 270ml/h may cause simultaneous flow from secondary and primary fluid sources.

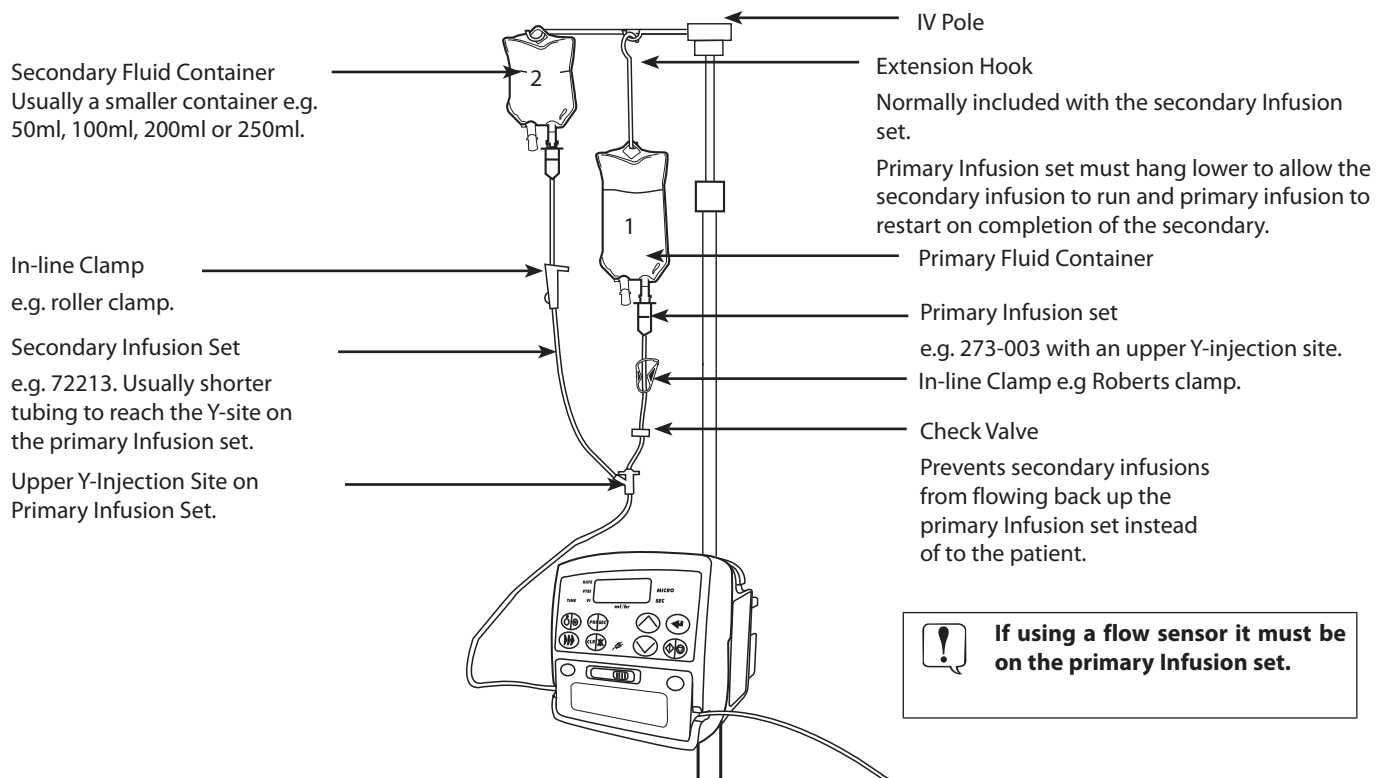

Typical Secondary Infusions:



If using a flow sensor it must be on the primary Infusion set.

Basic Features

Rate Titration



1. Enter the new infusion rate using the   keys.
2. Press  button to confirm the infusion rate.
Note: The rate can be increased or decreased without interrupting the infusion.



If the new rate selected is not confirmed the pump will revert to the current rate and no change in the infusion rate will occur.

Bolus Infusions

To administer a bolus infusion:

1. Press  button once and *bol* will be displayed.
2. Press and Hold  button while *bol* is still displayed, release  button after administering the desired bolus volume.
Note: Bolus volume given will be added to the total volume infused (VI) and subtracted from the volume to be infused (VTBI).

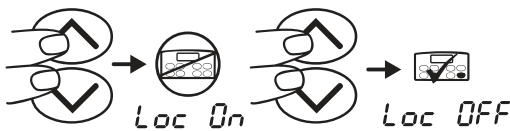

Panel Lock

The Panel Lock feature minimises the risk of unintentional changes to the infusion settings, whilst infusing.





If Panel Lock is enabled then *Loc* displays for all (non-operational) button presses.

Panel Lock prevents button operation with the exception of:

- Scrolling between infusion parameters using the  button.
- Muting the alarm using the  button.
- Pausing / resuming the infusion using the  button.

Optimising the Pumps Performance

Pump performance may be optimised by moving a new section of the infusion set in the pumping mechanism every 24 hours. To insert a new section of tubing:

1. Press  to place the infusion on HOLD.
2. Ensure the in-line clamp is closed.
3. Open the pump door, release the flow stop mechanism and move the Infusion set approximately 15cm along. See 'Loading the Infusion Set'.
4. Close the door, press  to restart the infusion.

Hold Mode

Press  to pause the infusion. Press  again to resume the infusion.

A call back alarm will activate if the pump is left on *Hold* for more than 2 minutes.

KVO (Keep Vein Open) Rate

At the end of infusion, the pump will continue to infuse at a very low rate (refer to 'Specifications' section of this DFU). KVO is used to keep the patients vein open, in order to prevent blood clots and catheter occlusions.



If the KVO rate is greater than the set infusion parameters then the pump will continue to infuse at the set infusion rate.

If the KVO rate has been configured to OFF the pump will stop infusing and generate an alarm.

Changing the Infusion Set

1. Press  to put the pump ON HOLD.
2. Close in-line clamp and ensure the IV access to the patient is isolated.
3. Disconnect the Infusion set from the patient.
4. Open pump door and remove Infusion set from the pump and discard the set and fluid container according to hospital protocol.
5. Place new Infusion set into pump, see 'Loading the Infusion Set'.
6. Squeeze the drip chamber approximately half full or up to fill line (if the drip chamber is marked) with fluid.
7. Prime the set manually.
8. Restart infusion, see 'Getting Started'.



When changing the Infusion set or the fluid container use aseptic technique according to hospital protocol. It is recommended that Infusion sets are changed in accordance with the Directions for Use. Carefully read the Directions For Use supplied with the Infusion set prior to use. The set change interval is 24 hours.

Changing the Fluid Container

1. Press  to put the pump ON HOLD.
2. Remove bag spike on Infusion set from empty / used container. Discard empty / used container according to hospital protocol.
3. Insert spike into new container.
4. Squeeze the drip chamber approximately half full or up to fill line (if the drip chamber is marked) with fluid.
5. Restart infusion, see 'Getting Started'.



When changing the Infusion set or the fluid container use aseptic technique according to hospital protocol. It is recommended that Infusion sets are changed in accordance with the Directions for Use. Carefully read the Directions For Use supplied with the Infusion set prior to use.

SmartSite® Needle-Free System Instructions

SmartSite® Needle-Free Valve is designed to permit safe gravity flow and automated flow, injection and aspiration of fluids without the use of needles by utilising Luer lock and Luer slip connectors.



Precautions:

Discard if packaging is not intact or protector caps are unattached.

If SmartSite® Needle-Free Valve is accessed by a needle in an emergency the valve will be damaged causing leakage. Replace SmartSite® Needle-Free Valve immediately.

SmartSite® Needle-Free Valve contraindicated for blunt cannula system.

DO NOT leave slip Luer syringes unattended.

DIRECTIONS - Use Aseptic Technique

1. Prior to every access, swab top of SmartSite® Needle-Free Valve port with 70% Isopropyl alcohol (1-2 seconds) and allow to dry (approximately 30 seconds).

NOTE: Dry time is dependent on temperature, humidity, ventilation of the area.

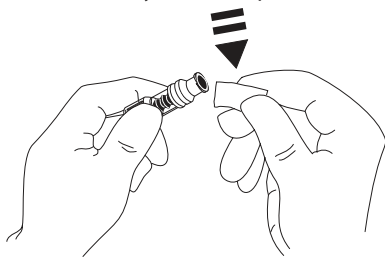





2. Prime valve port. If applicable, attach syringe to SmartSite® Needle-Free Valve port and aspirate miniscule air bubbles.
3. When used with administration sets always refer to individual set directions for use as change interval may vary according to clinical application (e.g. infusions of blood, blood products, and lipid emulsions).

NOTE: During use of Needle-Free Valve port, fluid may be observed between the housing and blue piston. This fluid does not enter the fluid path and requires no action.

NOTE: For product questions or needle-free valve educational materials, contact your CareFusion representative. Consult facility protocols. Consult other organisations that publish guidelines useful in developing facility protocols.

Clearing Air-In-Line

1. Press  button to silence the air-in-line alarm and put the pump on hold.
2. Close the in-line clamp.
3. Open the door to view the air bubble.
NOTE: Air-in-line alarms can be activated by both single bubbles and bubbles accumulated over time.
4. Disconnect the Infusion set from the patient and ensure the IV access to the patient is isolated.
5. Close the door.
6. Open the in-line clamp.
7. Press the  button once and *FILL* will be displayed.
8. Press and hold the  button while *FILL* is still displayed until there is no visible air in the IV line (according to hospital protocol).
9. Close the in-line clamp.
10. Attach the Infusion set to the patient.
11. Open the in-line clamp and restore the IV access to the patient.
12. Press the  button to resume the infusion.



Use aseptic technique according to hospital protocol.



Infusion sets without an in-line anti-siphon valve must be clamped before disconnecting from the patient and the prime (*FILL*) procedure will not be necessary to remove the air-in-line, as the air can be removed by gravity.

User Selectable Options





To set the user options the pump must be on *HoLd* or in set-up mode, and the relevant user selectable options are enabled. See also 'Configurable Options' section in this DFU.





Press  button and hold for 2 seconds to enter User Selectable Options.

Note: Number of  button presses are dependent upon the User Select Mode Options which have been enabled. The following instructions are based upon all options being enabled.





Setting the Occlusion Pressure Level

1. When **PrES** is displayed.
2. Select **HI**, **nor** or **Lo** using the   keys to set the occlusion pressure level to High, Normal or Low.
3. Press  button to return to *HoLd* or set-up mode or next option.

Setting the Alarm Volume





1. Press  button until **tonE** is displayed.
2. Select an alarm volume between **1** (Low) and **7** (High) using the   keys.
3. Press  button to return to *HoLd* or set-up mode, or next option.

Setting a VTBI / Time Infusion

1. Press  button until **CLoc** is displayed.
2. Select **On** or **OFF** using the   keys to turn the VTBI / time infusion setting on or off.
3. Press  button to return to *HoLd* or set-up mode, or next option.
4. Make sure that the TIME indicator is lit if set to on.

Note: The TIME increases / decreases in rate dependant units e.g. 10ml @ 99.9ml/h is 6mins, therefore 0:06 is displayed.

Setting to Micro Mode

1. Press  button until **0.0** is displayed.
2. Select **On** or **OFF** using the   keys to turn micro mode on or off.
3. Press  button to return to *HoLd* or set-up mode, an audible sounder will confirm the status.
4. Make sure that the **MICRO** indicator is lit if set to on.

Configurable Options Sheet



The default settings are configurable as displayed in brackets in the table below. Each of the configurable options has a code which must only be altered by qualified service personnel with reference to the technical service manual (TSM) for this product (Technical Service Manual reference: 1000SM00006 and Addendum 1000SM00014).

Description	Range	Default	Setting
Enable VTBI / time infusions	(On / OFF)	OFF	
Maximum priming volume	(OFF, 1 to 40 ml)	40ml	
Clear infusion parameters to zero on power - up	(On / OFF)	OFF	
Maximum VTBI in MICRO Mode	(0.1 to 999 ml)	999ml	
Bolus rate	(1 to 999ml/h)	400ml/h	
Maximum bolus volume	(OFF, 1 to 99ml)	5ml	
Keep vein open rate	(OFF, 1.0 to 5.0 ml/h)	5.0ml/h	
Air in line alarm volume - single bubble	(50,100, 250, 500µL)	100µl	
Enable secondary infusion capability	(On / OFF)	OFF	
Default occlusion pressure on power - up	(Lo (250mmHg),Nor (350mmHg), HI (500mmHg))	HI	
Alarm volume level	(1 - 7)	4	
Enable Micro mode	(On / OFF)	OFF	
Maximum infusion rate	(1 - 999 ml/h)	999ml/h	
Enable ASCII mode for communications	(On / OFF)	OFF	
Enable Odd parity for communications	(On / OFF)	OFF	
Set Pump address for communications	(1 - 250)	1	
Flow Sensor Connection Mode**	(AUTO/On)	On	
Set - up of current time and date	(00:00 to 23:59) (01/01/00 to 31/12/99)	N/A	
Language selection	(EnGL, FrAn, dEut, ItAL, ESPA, SE, nEd)*	EnGL	
IrDA Communications Selection	(On / OFF)	On	
Nurse Call Activation High Enabled	(On / OFF)	On	
Drops per ml of fluid	(1 to 200)	20	
Enable Automatic Set Detection and Anti-bolus Function***	(On / OFF)	OFF	
Silent Mode	(On / OFF)	OFF	
User select mode options			
Pressure limit Enabled	(On / OFF)	OFF	
Alarm volume Enabled	(On / OFF)	OFF	
Timed infusions Enabled	(On / OFF)	OFF	
Micro infusions Enabled	(On / OFF)	OFF	
Flow sensor sensitivity level	(Nor, Hi)	Nor	

*EnGL - English, FrAn - French, dEut - German, ItAL - Italian, ESPA - Spanish, SE - Swedish, nEd - Dutch.



** If infusion sets without anti-siphon valves are being used, it is recommended to change the flow sensor connection mode setting to **On**. With **On** selected, the Alaris® GW Volumetric Pump will not operate unless a flow sensor is connected.

*** When using dedicated CareFusion Infusion sets (refer to Compatible Dedicated Infusion Sets section) ensure that the set detection mode is **On** (Refer to Automatic Set Detection section for more details). Align all Alaris® GW Volumetric Pumps in your hospital to the same set detection mode (ie. all **On** or all **OFF**) to avoid potential confusion amongst users as to the mode in which the pump is operating under.

Serial Number	_____	Software Version	_____
Configured by	_____	Date	_____
Approved by	_____	Date	_____

Alarms

Alarms stop the infusion and are indicated by a combination of an audible alarm and a message on the display.





1. Check the display for an alarm message and review table below for cause and action. Press  to silence the alarm. (Exceptions are *Err* and *bAt*)
2. When the cause of the alarm has been rectified, press the  button to resume the infusion.

Display	Cause	Action
<i>Air OCCL</i>	AIR-IN-LINE UPSTREAM OCCLUSION	See 'Clearing Air-In-Line'. Remove the occlusion / air and restart the infusion by pressing the  button.
<i>bAt</i>	INTERNAL BATTERY DEPLETED	To silence the alarm connect the pump to AC power. Restart operation on AC power to charge the internal battery.
<i>door</i>	DOOR OPEN Door was opened during an infusion.	Close the door and restart the infusion.
<i>Err</i>	SYSTEM FAULT	Switch pump off. Remove pump from service and have the pump inspected by qualified service personnel.
<i>FLo Err</i>	FLOW ERROR No drops have been detected during an infusion (empty container). Excessive increase or decrease of fluid flow detected by flow sensor. Flow sensor attached to secondary Infusion set.	Clamp the tubing to stop fluid flow. Ensure that the infusion set tubing is properly loaded in the pumping channel following the flow direction label. Ensure that ample fluid is in the fluid container. Check for blockage / occlusion in infusion set. After the tubing is properly inserted, close the pump door and resume infusion. Ensure flow sensor is attached to the primary infusion set.
<i>FLo SENS</i>	FLOW SENSOR CONNECTION ERROR Flow sensor connected / disconnected during an infusion. Flow sensor is not connected and the primary VTBI is OFF . Too much fluid in drip chamber.	Restart the infusion with the flow sensor connected / disconnected, as required. Connect flow sensor or set a VTBI and re-start the infusion. Ensure fluid in the drip chamber is not above the fill line.
<i>HI PrES</i>	DOWNSTREAM OCCLUSION A blockage has occurred downstream.	Remove pressure in the infusion set to prevent a post occlusion bolus to the patient. Remove the cause of the blockage. Restart the infusion.
<i>bAd SET</i>	Incorrect infusion SET, set incorrectly loaded or set worn. Excessive amount of air in line. Infusion started with upstream tubing clamped. 273-003 set loaded with upper Y-site too close to pump.	Remove the infusion set and load the correct or new set (see 'Compatible Dedicated Infusion Sets'). Clear air from set. (Refer to 'Clearing Air-In-Line' section) Release clamp and restart. Reload set with pump at least 30cm from the Y-site.

Warnings

Warnings alert the user but may not stop the infusion and are indicated by an audible alarm, a message on the display or both.

1. Check the display for a warning message. Press  to silence the alarm.
2. Rectify the cause of the warning or proceed with caution.

Display	Cause	Action
<i>bol</i>	Bolus is being administered.	Release  button to return to infusion once correct bolus has been administered.
<i>End</i>	Finished pre-set volume to be infused.	Pump will infuse at the keep vein open rate, until the  button is pressed. Refer to 'KVO Rate' section of this DFU.
<i>FILL</i>	The pump is priming the Infusion set.	Ensure all air has been primed out of the infusion set, before starting the infusion.
<i>Lo bAt</i>	Low Battery (At least 30 mins before bAt alarm).	Connect pump to an AC power source.
<i>Hold</i>	The pump is on hold.	Press  to return to infusion, or press  to return to set-up.
<i>Attn</i>	The pump has been left unattended for 2mins and infusion has not started.	Attend to pump.
<i>tEst</i>	Automatic set check.	Allow test to complete before operating the pump further.

Flow Sensor Operation



The flow sensor automatically monitors the infusion flow rate through the drip chamber. The flow sensor will cause the pump to alarm if a significant deviation from the infusion rate occurs. The flow sensor will also be able to detect empty containers. For this reason, use of a flow sensor is mandatory when the automatic set detection mode on the pump is disabled.

Flow Sensor Usage

Alaris® GW Volumetric Pump mode	Infusion set with anti-siphon valve ?	Use flow sensor ?
Set detection On *	YES	OPTIONAL
Set detection On *	NO	RECOMMENDED
Set detection Off **	YES	MANDATORY
Set detection Off **	NO	MANDATORY

* Only CareFusion dedicated infusion sets can be used in this mode.

** CareFusion does not recommend the use of other manufacturers' Infusion Sets

Model 180 Flow Sensor

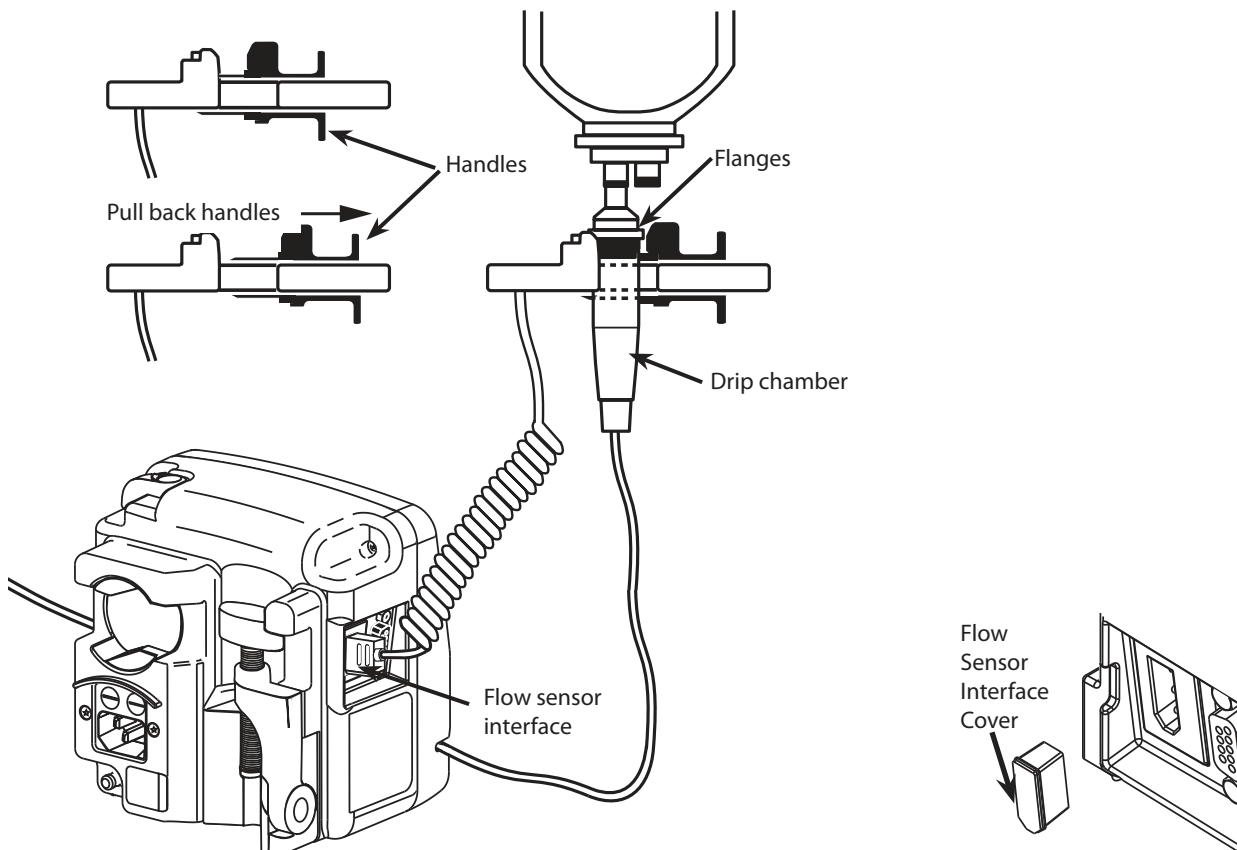

1. Plug the flow sensor into the flow sensor interface located on the top rear part of the pump.
2. Attach the Model 180 Flow Sensor to the drip chamber of the Infusion set, by pulling back the handles. Refer to the illustration above.
3. Proceed with load, priming, and set-up instructions as described in section 'Getting Started'.

NOTE: Ensure drip chamber is half full and upright.



Always attach the flow sensor before you start an infusion.

Avoid using the flow sensor in direct sunlight.

Always ensure lens is clean.

Always replace the flow sensor interface cover when the flow sensor is disconnected.

Compatible Dedicated Infusion Sets

The pump uses standard, single-use, disposable Infusion sets with Luer-lock connectors. The user is responsible for verifying the suitability of a product used, if it is not recommended by CareFusion.



CareFusion recommends the use of infusion sets with anti-siphon valves whenever possible. The anti-siphon valve prevents free flow from occurring if an infusion set is incorrectly loaded or removed from the pump.

New sets are continuously being developed for our customers. Please contact your local CareFusion representative for availability.

It is recommended that Infusion sets are changed in accordance with the Directions for Use. Carefully read the Directions For Use supplied with the Infusion set prior to use.

Please note these drawings are not to scale

Standard Sets

273-001 Infusion set with 15µm filter in drip chamber, anti-siphon valve. (220 cm)

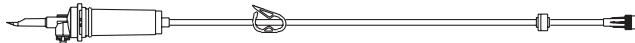

273-002 Infusion set with 15µm filter in drip chamber, 1 Y site and anti-siphon valve. (220 cm)

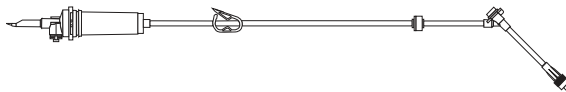

273-003 Infusion set with 15µm filter in drip chamber, 2 Y sites, back check valve and anti-siphon valve. (220 cm)

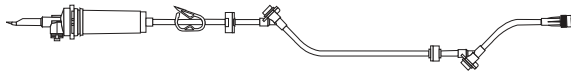

273-004 Infusion set with 15µm filter in drip chamber, roller clamp and Luer back check valve. (210 cm) Suitable for gravity infusion.

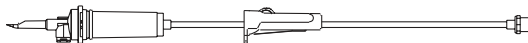

273-005 Infusion set with roller clamp. (225 cm) Suitable for gravity infusion.



273-303E Infusion set with 15µm filter in drip chamber, two anti-siphon valves and two SmartSite® Valve Y Port. (290 cm)

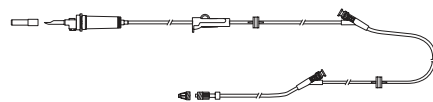

273-304 Infusion set with 15µm filter in drip chamber. (275 cm) Suitable for gravity infusion.



Blood Sets

273-007 Blood set with 1 upper Y site, in-line drip chamber with 200µm filter, and Luer back check valve. (285 cm) Suitable for gravity infusion.

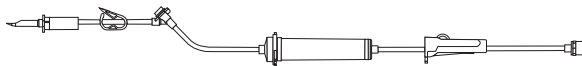

273-008 Blood set with 1 upper and 1 lower Y site, back check valve, in-line drip chamber with 200µm filter and Luer back check valve. (285 cm) Suitable for gravity infusion.

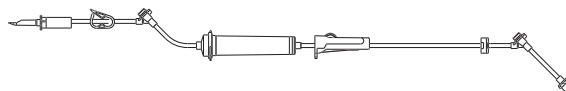

273-080 Blood set with 2 spikes, 1 upper and 1 lower Y site with anti-siphon valve and in-line drip chamber with 200µm filter. (225 cm)

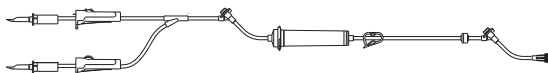

Filter Sets

273-009 1.2µm filter set with anti-siphon valve, with 15µm filter in drip chamber. (230 cm)



Burette Sets

273-103 Burette set with 1 Y site and anti-siphon valve. (220 cm)



Opaque Sets

273-011 Opaque PVC infusion set with anti-siphon valve and pump segment with 15µm filter in drip chamber. (235 cm)

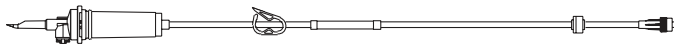

Low Sorbing Sets

273-053 Low Sorbing PVC infusion set with anti-siphon valve and pump segment with 15µm filter in drip chamber. (260 cm)

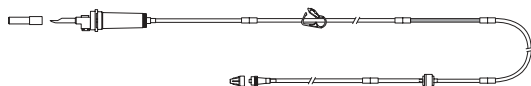

Secondary Sets

72213-0006 Secondary / Piggyback set with 18G needle and hanger. (approx. 84 cm)

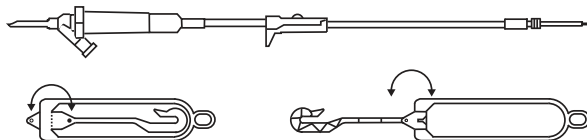

72213N-0006 Secondary / Piggyback set and extension hook. (approx. 76 cm)

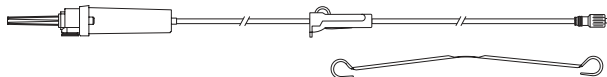

Filter Extension Sets

C20128 Extension set with 1.2µm filter and one Y site. Rotating male Luer lock. (approx. 51 cm)



C20350 Extension set with 0.2µm filter and one Y site. Rotating male Luer lock (approx. 51 cm) Low Sorbing (Polyethylene Lined)



20128E-0006 Extension set with 1.2µm filter and one SmartSite® Valve Y port. Rotating male Luer lock. (approx. 51 cm)

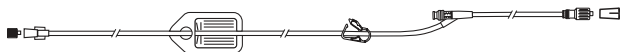

20350E-0006 Extension set with 0.2µm filter and one SmartSite® Valve Y port. Rotating male Luer lock (approx. 51 cm) Low Sorbing (Polyethylene Lined)



Oncology Sets

MFX273-950E Oncology set with five SmartSite® Valve Y ports.

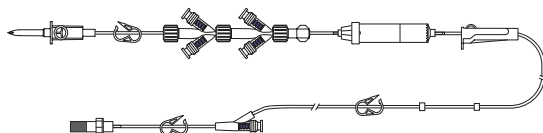

MFX273-952E Amber Oncology set with five SmartSite® Valve Y ports.

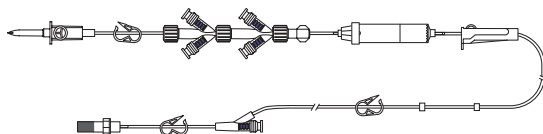

For the following infusion sets carefully read the Directions For Use supplied with the Infusion set prior to use for information on the use of the flow sensor with the infusion sets:

- MFX273-950E
- MFX273-952E

Associated Products

The Alaris® Gateway Workstation

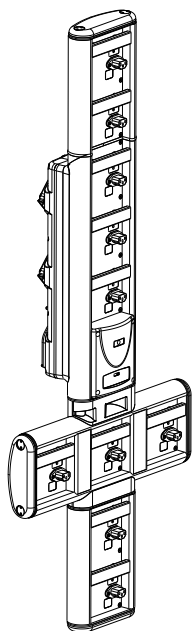

Product SKU	80203UNS0y-xx
Supply Voltage	115-230VAC, ~50-60Hz
Electrical Rating	460VA (Maximum)
Protection Against Electrical Shock	Class 1
Classification	Continuous Operation
Supply to Pump	115-230V, ~50-60Hz, 60VA

The Alaris® DS Docking Station

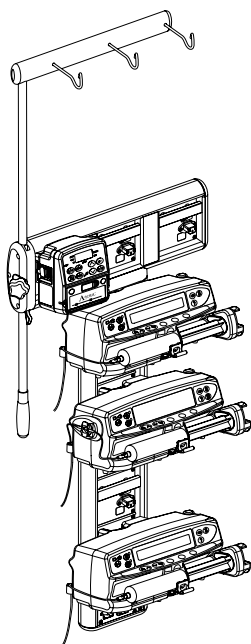

Product SKU	80283UNS00-xx
Supply Voltage	230VAC, 50 or 60Hz
Electrical Rating	500VA (nominal)
Protection Against Electrical Shock	Class 1
Classification	Continuous Operation
Supply to Pump	20VA max 230V 50-60Hz

y = Connectivity option - 1, 2 or 3

xx = Configuration

Maintenance

Routine Maintenance Procedures

To ensure that this pump remains in good operating condition, it is important to keep it clean and carry out the routine maintenance procedures described below. All servicing should only be performed by qualified service personnel with reference to the Technical Service Manual (TSM).

Circuit diagrams and components parts lists and all other servicing information which will assist the qualified service engineer in performing repair of the parts designated as repairable are available upon request from CareFusion.



If the pump is dropped, damaged, subjected to excessive moisture or high temperature, immediately take it out of service for examination by qualified service personnel.

All preventative and corrective maintenance and all such activities shall be performed at a compliant work place in accordance with the information supplied. CareFusion will not be responsible should any of these actions be performed outside the instructions or information supplied by CareFusion.

Interval

As per hospital policy
Each usage

Routine Maintenance Procedure

Thoroughly clean external surfaces of the pump before and after prolonged period of storage.

1. Inspect AC power supply plug and cable for damage.
2. Inspect case, keypad and mechanism for damage.
3. Check Start up self-test operation is correct.
4. Check for activation of both the alert indicator and audio function during the Pump start-up.

Before the transfer of the Pump to a new patient and as required

Clean the Pump by wiping over with a lint-free cloth lightly dampened with warm water and a standard disinfectant/detergent solution.



Please refer to Technical Service Manual for calibration procedures. The units of measurement used in the calibration procedure are standard SI (The International System of Units) units.



It is important to ensure that you only refer to the most recent version of the Directions for Use and Technical Service Manual for your CareFusion products. These documents are referenced on www.carefusion.com. Copies can be obtained by contacting your local CareFusion representative.

Battery Operation

The internal rechargeable battery allows continued operation when the AC power is unavailable, for example during patient transfer or AC power failure. The infusion time on battery is rate dependant, see 'Specifications' section of the DFU. From the battery low alarm it will take about 24 hours to fully recharge when reconnected to the AC power supply, whether the pump is in use or not. The battery is automatically charged during AC operation and whenever the pump is connected to the AC power supply and the AC power indicator is illuminated.

The battery is maintenance free, sealed Nickel Metal Hydride and requires no routine servicing. However, to achieve optimum operation, ensure that the battery is fully recharged after full discharge, before storage, and at regular 3 month intervals during storage.

Charge retention will eventually degrade. Where retention is critical the internal battery should be replaced every 3 years.

It is recommended that only qualified service personnel replaces the battery. For further information regarding the replacement of batteries refer to the Technical Service Manual.

Any use of battery packs that are not manufactured by CareFusion in the Alaris® Volumetric Pump is at your sole risk, and CareFusion does not provide any warranty for or endorsement on any battery packs that are not manufactured by CareFusion. CareFusion's product warranty shall not apply in the event the Alaris® Volumetric Pump has suffered damage or premature wear, or malfunctions or otherwise operates incorrectly, as a result of use with a battery pack that is not manufactured by CareFusion.

Disposal

Information on Disposal for Users of Waste Electrical & Electronic Equipment

This  symbol on the product and/or accompanying documents means that used electrical and electronic products should not be mixed with household waste.

If you wish to discard electrical and electronic equipment, please contact your CareFusion affiliate office or distributor for further information.

Disposing of this product correctly will help to save valuable resources and prevent any potential negative effects on human health and the environment which could otherwise arise from inappropriate waste handling.

Information on Disposal in Countries outside the European Union

This symbol is only valid in the European Union. The product should be disposed of taking environmental factors into consideration. To ensure no risk or hazard, remove the internal rechargeable battery and the Nickel Metal Hydride battery from the control board and dispose of as outlined by the local country regulations. All other components can be safely disposed of as per local regulations.

Cleaning and Storage

Cleaning the pump

Before the transfer of the pump to a new patient and periodically during the use, clean the pump by wiping over with a lint-free cloth lightly dampened with warm water and a standard disinfectant / detergent solution.

Do not use the following disinfectant types:

- Disinfectants which are known to be corrosive to metals must not be used, these include:
 - NaDcc (such as Presept),
 - Hypochlorites (such as Chlorasol),
 - Aldehydes (such as Cidex),
 - Cationic Surfactants (such as Benzalkonium Chloride).
- Iodine (such as Betadine) will cause surface discoloration.
- Concentrated Isopropyl alcohol based cleaners will degrade plastic parts.

Recommended cleaners are:

Brand	Concentration
Hibiscrub	20% (v/v)
Virkon	1% (w/v)

The following products were tested and are acceptable for use on the Pump if used in accordance with the specified manufacturer's guidelines.

- | | |
|---|-----------------------------|
| • Warm soapy water | • Tristel Fuse sachets |
| • Mild detergent in water (e.g. Young's Hospec) | • Tristel Trio wipes system |
| • 70% Isopropyl Alcohol in water | • Tuffie 5 wipe |
| • Chlor-Clean | • Virkon Disinfectant |
| • Clinell Sporidical wipes | • Virusolve+ (Ready To Use) |
| • Hibiscrub | • Virusolve+ (Wipes) |
| • TriGene Advance | |



Before cleaning always switch off and disconnect from the AC power supply. Do not allow liquid to enter the casing and avoid excess fluid build up on the pump.

Do not use aggressive cleaning agents as these may damage the exterior surface of the pump. Do not steam autoclave, ethylene oxide sterilise or immerse this pump in any fluid.

Storing the pump

If the pump is to be stored for an extended period it should be first cleaned and the internal battery fully charged. Store in a clean, dry atmosphere at room temperature and, if available, employ the original packaging for protection.

Once every 3 months during storage, carry out functional tests as described in the technical service manual and ensure that the internal battery is fully charged.



See the Technical Service Manual for further information regarding the charging of the RTC Battery BT1.

Cleaning and storing the Infusion set

The Infusion set is a disposable single use item and should be discarded after use according to hospital protocol.

Cleaning the Flow Sensor

Before the transfer of the flow sensor to a new Infusion set and periodically during use, clean the flow sensor by wiping over with a lint-free cloth lightly dampened with warm water and a standard disinfectant / detergent solution. Ensure the connector does not get wet. Dry flow sensor before use.

To aid cleaning of flow sensors which have been heavily soiled, contaminated or if the handle operation is not free moving, then the flow sensor may be immersed and soaked in clean soapy water (see [11](#)). The inside of the spring mechanism can be cleaned by activating it whilst submerged in the water.

After cleaning, the flow sensor should be allowed to dry fully prior to use.



The plug of the flow sensor must not be immersed in water as damage will occur.

Specifications

Electrical/Mechanical Safety

Complies with IEC/EN60601-1 and IEC/EN60601-2-24.

Electro Magnetic Compatibility (EMC)

Complies with IEC/EN60601-1-2 and IEC/EN60601-2-24.

Electrical Safety

IEC/EN 60601-1 - Typical earth leakage current 40µA.

Potential Equalisation Conductor

The function of the Potential Equalisation Connector (Conductor) is to provide a direct connection between the Pump and the potential equalisation busbar of the electrical installation. To use the Potential Equalisation Connector, connect the Potential Equalisation Connector on the Pump to the potential equalisation busbar of the electrical installation.

Dielectric Strength

Proof strength test 1.7kV dc (live and neutral to earth) for 10s

Performance strength test 500V dc (live and neutral to earth)

Proof Strength Test

The proof strength test is applied at the factory. It is not recommended that the proof strength test is reapplied if the pump is tested again during service.

Classification

Class I Equipment. Continuous, Portable Equipment, type 4.

AC Power Supply

100 - 120 VAC, 50 - 60Hz, 10VA (nominal).

220 - 240 VAC, 50 - 60Hz, 10VA (nominal).

Protection against fluid ingress

IPX1 - Protected against vertically falling drops of water.

Dimensions

137mm (w) x 140mm (h) x 105mm (d). Weight: approx. 1.5kg (excluding power cable).

Environmental Specifications

Condition	Operating	Transport and Storage
Temperature	+15°C - +38°C	-20°C - +50°C
Humidity	20% - 90%*	10% - 95%*
Atmospheric Pressure	700hPa - 1060 hPa	500hPa - 1060hPa

Priming the Infusion set / Prime

Parameter	Range
Priming Rate	Fixed:>999ml/h
Priming Volume	0 - 40ml***

Starting the Infusion / Set-up

Infusion Parameter	Micro	Standard
Flow Rate	1.0 - 99.9ml/h**	1 - 999ml/h***
VTBI	0.1 - 99.9ml** 100 - 999ml***	1 - 9999ml***
VI	0.0 - 99.9ml** 100 - 9999ml***	0 - 9999ml***

Administering a Bolus

Parameter	Range
Bolus Rate	1 - 999ml/h***
Bolus Volume	0 - 99ml***
Max Bolus Volume after release of hard occlusion	<0.6ml

*Non condensing.

**Measured in 0.1ml increments.

***Measured in 1ml increments.

Battery Specifications

Rechargeable NiMH (Nickel Metal Hydride). Automatically charges when the pump is connected to AC power.

Battery Life - 10 hours @ 25 ml/h

Battery Charging - 95% charge - < 24 hours (all conditions).

Alarm Conditions

SYSTEM ERROR	UPSTREAM OCCLUSION
AIR-IN-LINE	INCORRECT INFUSION SET
BATTERY DEPLETED	DOOR OPEN
DOWNSTREAM OCCLUSION	

Critical Volume

The maximum volume infused following a single fault condition is 1.0ml.

KVO Infusion Rate

Up to a max. of 5ml/h or the infusion rate if programmed less than the set KVO rate.

Occlusion Pressure

User Selectable: Occlusion Alarm Pressure at 125ml/h - 250mmHg (low), 350mmHg (normal), 500mmHg (high).

Fuse Type

2 XT 125 mA, slow blowing (100 - 120 VAC, nominal).

2 XT 63 mA, slow blowing (220 - 240 VAC, nominal).

Air Sensor

Integral Ultrasonic Sensor.

Air in line detector

Configurable 50µl, 100µl, 250µl, 500µl.

Total Time Setting

Up to 99 hours and 59 mins.

Memory Retention

The electronic memory of the pump will be retained for at least 6 months when not powered up.

Minimum Occlusion Alarm Pressure

100mmHg

Maximum Occlusion Alarm Pressure

1000mmHg

Bolus volume generated at 25.0 ml/h when the minimum occlusion alarm threshold is reached

0.3ml

Bolus volume generated at 25.0 ml/h when the maximum occlusion alarm threshold is reached

0.6ml

Maximum time for activation of occlusion alarm

Maximum time to alarm at 1.0ml/h is <45min (High Pressure)

Maximum time to alarm at 1.0ml/h is <30min (Low Pressure)

Maximum time to alarm at 25ml/h is <5.30min (High Pressure)

Maximum time to alarm at 25ml/h is <2.10min (Low Pressure)

Maximum time to alarm at 999ml/h is <3 secs (High Pressure)

Maximum time to alarm at 999ml/h is <2 secs (Low Pressure)

System Accuracy

Rate Accuracy $\pm 5\%$ at 25 ml/h under nominal conditions², tested to IEC60601-2-24 (95% confidence interval / 80% population).



For all conditions the rate accuracy should be adjusted accordingly.⁶

Bolus Volume Accuracy - $\pm 10\%$ @ 5ml under nominal conditions², tested to IEC60601-2-24. Under all conditions³ the bolus volume accuracy should be de-rated as for rate accuracy.

Occlusion Pressure Accuracy

± 150 mmHg under nominal conditions²

± 250 mmHg under all conditions³

Air in Line Accuracy

$\pm 20\%$ or $\pm 0.025\text{ml}^5$ under nominal conditions²



DISCLAIMER. This pump has been tested and approved by CareFusion for use only with CareFusion dedicated infusion sets. In the event the user is considering using infusion sets, not approved for use with the Alaris® GW Volumetric Pump, the user should consult an authorized CareFusion representative for compatibility and/or calibration information prior to use. In no event, however, does CareFusion make any representations or warranties concerning the adequacy and safe performance of any non-dedicated infusion sets as it relates to the operation of the pump and the accuracy of the infusion.

In no event shall CareFusion be liable for any damages of any kind or nature, including without limitation, direct or indirect, special, consequential, or incidental damages arising from, or in connection with, the use of non-dedicated infusion sets (Infusion sets not manufactured by CareFusion), regardless of whether CareFusion has been advised as to the possibility of such use.

Notes:

1. All accuracy specifications are with a 95% confidence interval / 95% population, unless stated otherwise.
2. Nominal conditions are defined as:
 - Set Rate: 125 ml/h (25 ml/h for rate accuracy);
 - Disposable Type: 273-001;
 - Needle: 18 gauge x 40 mm;
 - Solution Type: De-ionized & Degassed Water;
 - Temperature: 23° ± 2°C
 - Fluid Head Height: 0.3 ± 0.1 m;
 - Back Pressure: 0 ± 10 mmHg.
3. All are as normal conditions with the following additions:
 - Set Rate: 1 to 999 ml/h;
 - Solution Type: All fluids⁴;
 - Temperature: 15 to 38°C
 - Fluid Head Height: 0 ± 1.0 m;
4. Tested using Distilled water, 20% lipid, 50% glucose, 0.9% Normal Saline and 5% Alcohol solutions.
5. Whichever is the greater of the air in line limit set.
6. For all conditions the rate accuracy should be adjusted by the following percentages:
 - ± 10% over the infusion rate range 1 to 999 ml/h
 - Nominal: 0.68 (± 0.36)% over 24 hours of continuous use.
 - Nominal: -3.5 (± 1.08)% @ 15°C
 - Nominal: -0.9 (± 0.62)% @ 38°C

IrDA, RS232 and Nurse Call Specification

RS232 / IrDA Feature

The RS232 / IrDA feature is a standard feature on Alaris® GW Volumetric Pump. It allows the pump to be monitored remotely via a suitable central monitoring or computer system. It also enables the internal event log of the pump to be downloaded for technical support purposes.



The nurse call interface provides a remote backup to the internal audible alarm. It should not be relied upon to replace monitoring of the internal alarm.

Refer to the Technical Service Manual for further information regarding the RS232 interface. Since it is possible to control the pump using the RS232 interface at some distance from the pump and hence remote from the patient, responsibility for the control of the pump is vested in the software run on the computer control system.

The assessment for the suitability of any software used in the clinical environment to control or receive data from the pump lies with the user of the equipment. This software should include detection of the disconnection or other failure of the RS232 cable. The protocol is detailed in the Technical Service Manual and is for general information only.

Any connected analogue and digital components are required to meet IEC/EN60950 for data processing and IEC/EN60601 for medical devices. Anyone connecting additional devices to the signal input or output is a system configurator and responsible for meeting the requirements of the system standard IEC/EN60601-1-1.

Nurse Call Feature

The nurse call interface is for connection to a suitable monitoring device in order to provide remote indication of the pump entering an alarm condition.

RS232 / Nurse Call Connection Data

Typical Connection Data -

1. Nurse call (Relay) Normally Closed (NC C)
2. Transmit Data (TXD) Output
3. Received Data (RXD) Input
4. Power Input (DSR)
5. Ground (GND)
6. Not used
7. Power Input (CTS)
8. Nurse call (Relay) Normally open (NC O)
9. Nurse call (Relay) Common (NC COM)

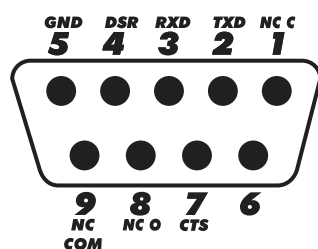

Trumpet and Flow Rate Curves

In this pump, as with all infusion systems, the action of the pumping mechanism and variations cause short-term fluctuations in rate accuracy.

The following curves show typical performance of the system in two ways: 1) the accuracy of fluid delivery over various time periods is measured (trumpet curves), and 2) the delay in onset of fluid flow when infusion commences (start-up curves).

Trumpet curves are named for their characteristic shape. They display discrete data averaged over particular time periods or 'observation windows', not continuous data versus operating time. Over long observation windows, short term fluctuations have little effect on accuracy as represented by the flat part of the curve. As the observation window is reduced, short term fluctuations have greater effects as represented by the mouth of the trumpet.

Knowledge of system accuracy over various observation windows may be of interest when certain drugs are being administered. Short term fluctuations in rate accuracy may have clinical impact depending on the half-life of the drug being infused and the degree of inter vascular integration, the clinical effect cannot be determined from the trumpet curves alone.

The start-up curves represent continuous flow versus operating time for two hours from the start of the infusion. They exhibit the delay in onset of delivery due to mechanical compliance and provide a visual representation of uniformity. Trumpet curves are derived from the second hour of this data. Tests performed per IEC60601-2-24 standard.



The trumpet and flow rate curves are representative of the typical performance of the Alaris® GW Volumetric Pump when used in combination with a typical dedicated infusion set. The user is responsible for assessing the performance of the Alaris® GW Volumetric Pump when used in combination with a non-dedicated infusion set.

Start-up Graph at 1.0ml/h (Initial Period)
273-001 Infusion Set

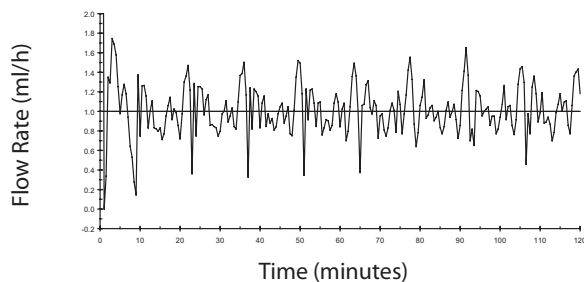

Start-up Graph at 25.0ml/h (Initial Period)
273-001 Infusion Set

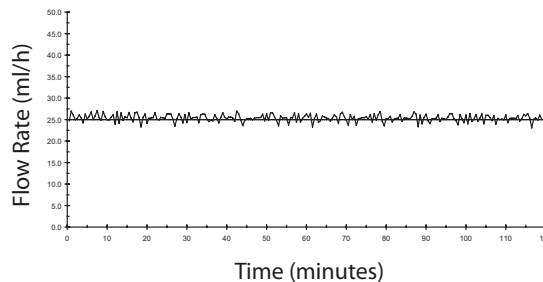

Trumpet Graph at 1.0ml/h (Initial Period)
273-001 Infusion Set

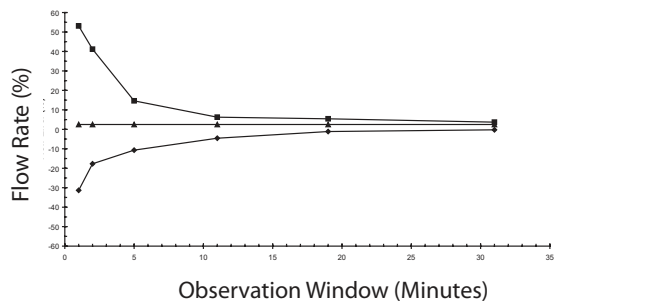

Trumpet Graph at 25.0ml/h (Initial Period)
273-001 Infusion Set

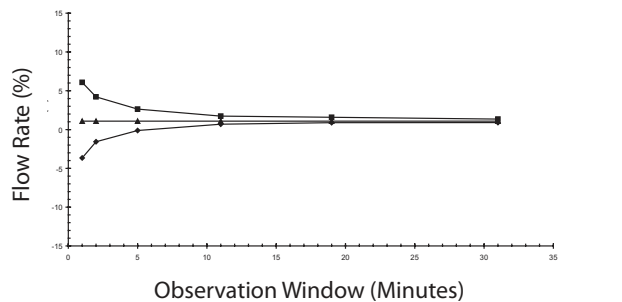

■ Maximum Rate Error ◆ Minimum Rate Error ▲ Overall Mean Error
= +2.5%

■ Maximum Rate Error ◆ Minimum Rate Error ▲ Overall Mean Error
= +1.1%

Trumpet Graph at 1.0ml/h (After 24 Hours)
273-001 Infusion Set

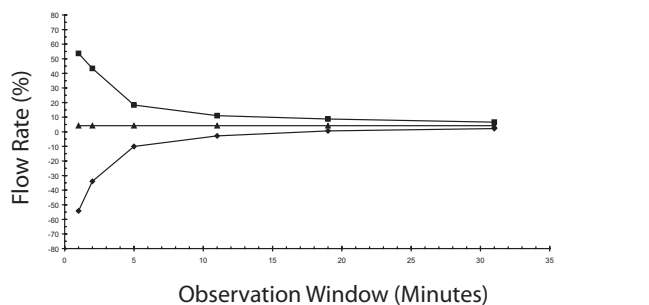

Trumpet Graph at 25.0ml/h (After 24 Hours)
273-001 Infusion Set

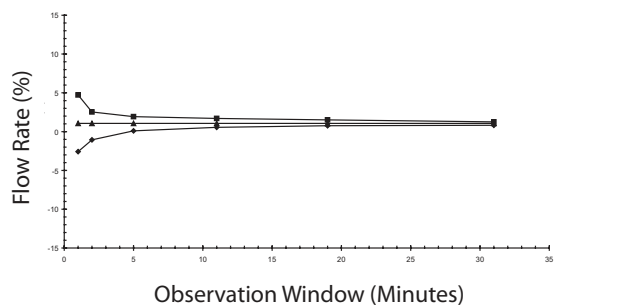

■ Maximum Rate Error ◆ Minimum Rate Error ▲ Overall Mean Error
= +4.2%

■ Maximum Rate Error ◆ Minimum Rate Error ▲ Overall Mean Error
= +1.1%

Note: The typical flow rate and trumpet curves - Infusion set 273 001

Technical Description

The following details outline the basic safety checks designed into the pump to minimise the possibility of under or over infusions.

Power on Self-Tests

The pump is single fault tolerant, which means the pump will either stop and alarm, or continue to infuse uninterrupted as a result of a single fault failure. During the power on self-test sequence the pump automatically performs system integrity checks and will alarm and display *Err* should any of these tests fail. Refer to 'Power On/Off' section of this DFU.

Air-in-Line

Two ultrasonic transducers continuously check for the presence of air in the Infusion set throughout the infusion. This air-in-line feature operates in two modes:

- Single Bubble Detection - The pump will alarm and display *Air OCCL* whenever a single air bubble greater than the air in line volume alarm limit is detected. The alarm limit can be configured to 50, 100, 250 or 500 μL . See also 'Configurable Options' section of this DFU.
- Air-in-Line Accumulation - This accumulation feature monitors the volume of air that passes through the Infusion set by accumulating the volume of individual bubbles over a 15 minute window. This feature is particularly useful with infusions for patients that are highly sensitive to air (i.e. infants, paediatrics) or when infusing products that create significant volumes of small air bubbles.



Although an individual bubble may not exceed the pre-programmed threshold, the additive volume of bubbles in a 15 minute volume may be sufficient to initiate an air-in-line alarm indicated by an Air OCCL message.

Downstream Occlusion Pressure

The pump includes a pressure sensor to monitor the downstream Infusion pressure. When the IV pressure exceeds the alarm pressure limit, as a result of, for example kinked IV tubing or blocked cannula, the pump will alarm and display *HI PrES*.

To compensate for the variability in Infusion set tubing the pump performs a relative, baseline pressure measurement. The pump takes a reference pressure from the IV line when the infusion commences and alarms at a preset limit above the baseline pressure. The pressure alarm limits are 250, 350 and 500 mmHg above the baseline pressure, corresponding to the low, normal or high, pressure limits. To avoid excessively large pressures the pump is capped at 1000 mmHg.

Upstream Occlusion Pressure

To detect upstream occlusions resulting from, for example, closed clamps or occluded drip chamber filters the pump continuously monitors the upstream IV tubing pressure. Upon detection of an occlusion the pump will alarm and display *Air OCCL*. The pump uses the ultrasonic transducers of the air sensor to monitor for upstream occlusions and is therefore unable to differentiate an upstream occlusion from an air bubble.

Pump Based Free Flow Protection

The pump is equipped with a flow stop mechanism that is designed to occlude the IV tubing when the pump door is open and the tubing remains properly loaded in the pump. Raising the flow stop mechanism lever arm and pushing it to the right activates this mechanism. Once activated, the user inserts the IV tubing into the tubing guide channel.

When the pump door is closed, the bevel integrated into the door releases the lever arm such that it will automatically occlude the tubing when the door is re-opened. (Refer to 'Features of the Alaris® GW Volumetric Pump') The tubing can be removed from the tubing guide channel by repeating the activation of the lever arm. Once the lever arm is re-activated and the door is opened, the flow stop mechanism no longer occludes flow in the tubing.

Anti-Bolus Function

The anti-bolus function is designed to reduce the bolus that may occur upon the release of an occlusion following a downstream occlusion alarm. (Detection of a downstream occlusion is indicated by a *HI PrES* alarm.) The pump returns the Infusion set line pressure to neutral within 15 seconds by pumping backwards briefly and measuring the Infusion set line pressure through the in-line pressure detection system. This feature can prevent the fluid bolus to the patient that can occur upon the release of an occlusion, which may be caused by a downstream clamp.

Note: The anti-bolus function is disabled if the automatic set detection feature is to be switched off; refer to 'Configurable Options' section of this DFU.

Products and Spare Parts

Alaris® Infusion System

Range of products in the Alaris® Infusion System product family are:

Part Number	Description
8002MED01	Alaris® GH Syringe Pump (with Plus Software)
8003MED01	Alaris® CC Syringe Pump (with Plus Software)
80043UN01	Alaris® TIVA Syringe Pump
80053UN01	Alaris® PK Syringe Pump
8003MED01-G	Alaris® CC Guardrails® Syringe Pump (with Plus Software)
8002MED01-G	Alaris® GH Guardrails® Syringe Pump (with Plus Software)
9002MED01	Alaris® GP Volumetric Pump (with Plus Software)
9002MED01-G	Alaris® GP Guardrails® Volumetric Pump (with Plus Software)
80203UNS0x-xx ¹	Alaris® Gateway Workstation

¹ For Workstation contact local customer services representative to obtain configurations availability and part numbers.

Spare Parts

A comprehensive list of spare parts for this pump is included within the *Technical Service Manual*.

The *Technical Service Manual (1000SM00006)* is now available in electronic format on the World Wide Web at :-

www.carefusion.co.uk/alaris-technical/

A username and password are required to access our manuals. Please contact a local customer services representative to obtain login details.

Part Number	Description
1000EL00349	Internal Battery Pack
1001FAOPT91	AC Power Lead - UK
1001FAOPT92	AC Power Lead - European

Service Contacts

For service contact your local Affiliate Office or Distributor.

AE	DE	GB	NZ
CareFusion, PO Box 5527, Dubai, United Arab Emirates.	CareFusion, Pascalstr. 2, 52499 Baesweiler, Deutschland.	CareFusion, The Crescent, Jays Close, Basingstoke, Hampshire, RG22 4BS, United Kingdom.	CareFusion, 14B George Bourke Drive, Mt Wellington 1060, PO Box 14-518, Panmure 1741, Auckland, New Zealand
Tel: (971) 4 28 22 842	Tel: (49) 931 4972 837	Tel: (44) 0800 917 8776	Tel: 09 270 2420 Freephone: 0508 422734
Fax: (971) 4 28 22 914	Fax: (49) 931 4972 318	Fax: (44) 1256 330860	Fax: 09 270 6285
AU	DK	HU	PL
CareFusion, 3/167 Prospect Highway, PO Box 355 Seven Hills, NSW 2147, Australia.	CareFusion, Firskovvej 25 B, 2800 Lyngby, Danmark.	CareFusion, Döbrensei tér 1, H-1013 Budapest, Magyarország.	CareFusion, ul. Rzymowskiego 53, 02-697 Warszawa, Polska.
Tel: (61) 1800 833 372	Tlf. (45)70 20 30 74	Tel: (36) 1 488 0232 Tel: (36) 1 488 0233	Tel: (48) 225480069
Fax: (61) 1800 833 518	Fax. (45)70 20 30 98	Fax: (36) 1 201 5987	Fax: (48) 225480001
BE	ES	IT	SE
CareFusion, Leuvensesteenweg 248 D, 1800 Vilvoorde, Belgium.	CareFusion, Edificio Veganova, Avenida de La Vega, nº1, Bloque 1 - Planta 1, 28108 Alcobendas, Madrid, España.	CareFusion, Via Ticino 4, 50019 Sesto Fiorentino, Firenze, Italia.	CareFusion, Hammarbacken 4B, 191 46 Sollentuna, Sverige.
Tel: +32 (0) 2 267 38 99	Tel: (34) 902 555 660	Tél: (39) 055 30 33 93 00	Tel: (46) 8 544 43 200
Fax: +32 (0) 2 267 99 21	Fax: (34) 902 555 661	Fax: (39) 055 34 00 24	Fax: (46) 8 544 43 225
CA	FR	NL	US
CareFusion, 235 Shields Court, Markham, Ontario L3R 8V2, Canada.	CareFusion, Parc d'affaire le Val Saint Quentin 2, rue René Caudron 78960 Voisins le Bretonneux France	CareFusion, De Molen 8-10, 3994 DB Houten, Nederland.	CareFusion, 10020 Pacific Mesa Blvd., San Diego, CA 92121, USA.
Tel: (1) 905-752-3333	Tél: (33) 01 30 02 81 41	Tel: +31 (0)30 2289 711	Tel: (1) 800 854 7128
Fax: (1) 905-752-3343	Fax: (33) 01 30 02 81 31	Fax: +31 (0)30 2289 713	Fax: (1) 858 458 6179
CH	FI	NO	ZA
CareFusion, A-One Business Centre Zone d'activités Vers-la-Pièce n° 10 1180 Rolle / Switzerland	CareFusion, P O Box 121, Äyritie 8B, 01511 Vantaa	CareFusion, Fjordveien 3 1363 HØVIK Norge.	CareFusion, Unit 2 Oude Molen Business Park, Oude Molen Road, Ndabeni, Cape Town 7405, South Africa.
Ph.: 0848 244 433	Tel: +358 207871 090	Tel: (47) 64 00 99 00	Tel: (27) (0) 860 597 572 Tel: (27) 21 510 7562
Fax: 0848 244 100			Fax: (27) 21 5107567
CN			
CareFusion, 上海代表机构, 中国上海市张杨 路 500 号, 上海时代广场办事处大楼, A 座, 24 层, 邮编: 200122。 电话: (86) 21 58368018 传真: (86) 21 58368017			

Rev. H

Page Intentionally Left Blank

Alaris, Guardrails, SmartSite and IVAC are registered trademarks of CareFusion Corporation or one of its subsidiaries. All rights reserved.
All other trademarks are property of their respective owners.

© 2000-2014 CareFusion Corporation or one of its subsidiaries. All rights reserved.

This document contains proprietary information of CareFusion Corporation or one of its subsidiaries, and its receipt or possession does not convey any rights to reproduce its contents, or to manufacture or sell any product described. Reproduction, disclosure, or use other than for the intended purpose without specific written authorization of CareFusion Corporation or one of its subsidiaries is strictly forbidden.



CareFusion Switzerland 317 Sarl,
A-One Business Centre, Z.A Vers -La-
Pièce n° 10, CH-1180, Rolle



CareFusion UK 305 Ltd., The Crescent,
Jays Close, Basingstoke, Hampshire,
RG22 4BS, UK

1000DF00440 Issue 4