



Inverted Research Microscope ECLIPSE Ts2R

# ECLIPSE Ts2R

Inverted Research Microscope



Shedding New Light  
On **MICROSCOPY**

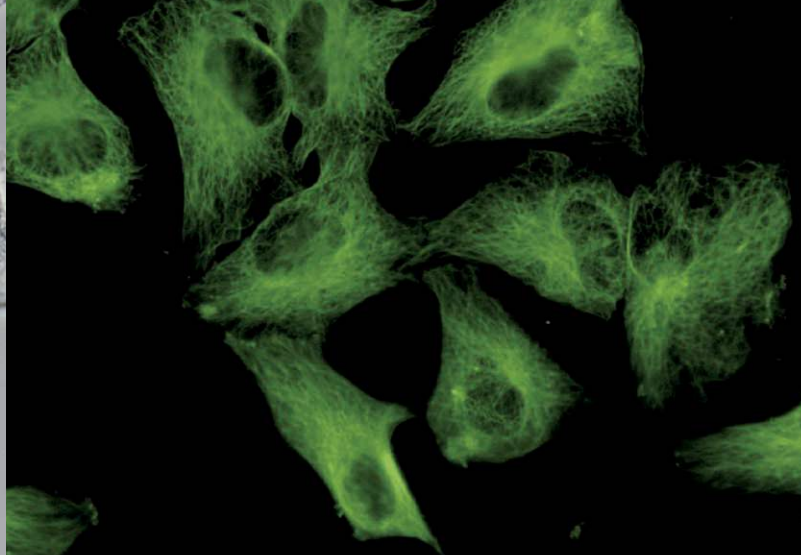
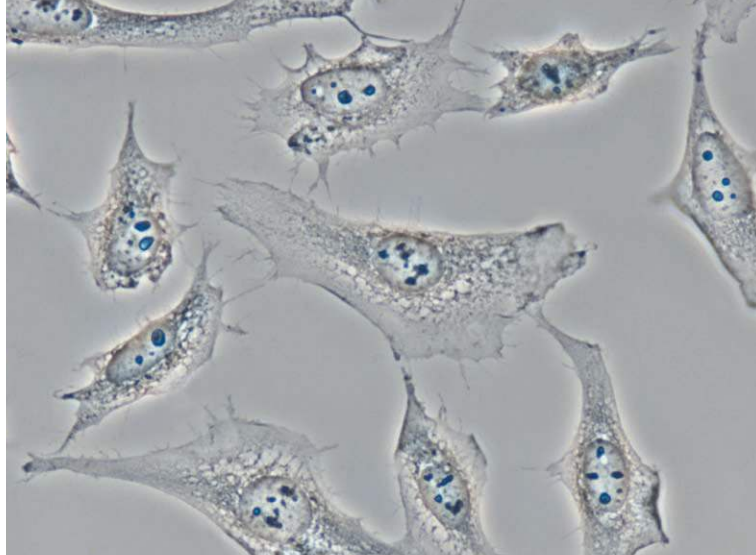

# Do more than before

## Easy to work with

### Simple operations

Control buttons on the Ts2R microscope are intuitively located for a streamlined workflow. The on/off and diascopic/epi-fluorescence switching controls are located on the front panel while buttons pertaining to either diascopic or epi-fluorescence control are zoned to the left and right sides of the microscope body, respectively.



### Newly developed mechanical stage option

The Ts2R can be configured with an optional rectangular mechanical stage. This stage provides a long travel stroke, enabling users to observe an entire well plate from end-to-end. You can also set limits to the travel stroke (three-way) to match frequently used samples or vessels. The stage handle is offered in two lengths, long or short, to further accommodate the user's needs.



### New ergonomic stage design for improved workflow

The Ts2R's stage height has been lowered by approximately 30% compared to the standard research microscope\*, thereby ensuring a comfortable hand position during repetitive operation and sample exchange. Moreover by lowering the support columns and positioning the camera port on the side of the tube, sample visibility is improved.

\*Comparison with Nikon's Inverted Research Microscope ECLIPSE Ti.



## Versatile applications with new LED illuminators

The high-intensity LED light source enables you to perform a wide variety of observation methods similar to the full-size, inverted research microscope ECLIPSE Ti. The Ts2R-FL model, which offers epi-fluorescence observation, provides four fluorescence channels and 7 different wavelengths to choose from.

	Ts2R	Ts2R-FL
DIA	<ul style="list-style-type: none"> <li>Brightfield</li> <li>APC (Apodized Phase Contrast)</li> <li>Spindle Observation</li> </ul>	<ul style="list-style-type: none"> <li>DIC</li> <li>Emboss Contrast</li> <li>NAMC (Nikon Advanced Modulation Contrast)</li> <li>Phase Contrast</li> </ul>
FL	—	<ul style="list-style-type: none"> <li>Epi-fluorescence</li> </ul>

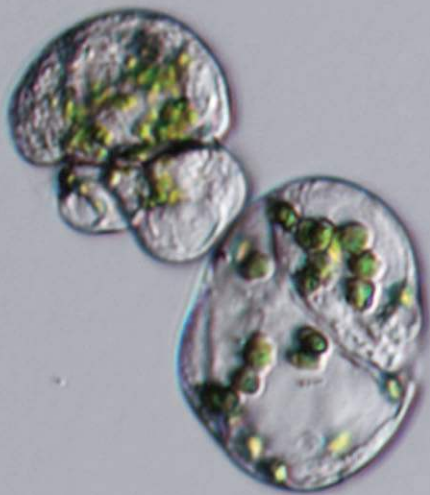

## A compact inverted microscope for your basic research needs

### Compact body

#### Compact body for streamlined workflow

Illumination modules including the epi-fluorescence light source have been seamlessly incorporated into the microscope main body, resulting in a compact and simple design form that's also durable. The compact structure is also vibration-resistant to provide highly stable sample observations.



#### Easily fits inside laminar flow hoods

The low stage and side-port camera position reduce user fatigue from repetitive stage manipulation and provides clear visibility of the stage and sample even with the hood sash lowered.

Additionally, by rotating the eyepiece tube 180° and fastening it in position, it is possible to have the microscope completely within the hood.



### High precision and quality

#### Advanced-optical performance

The Ts2R is compatible with Nikon's acclaimed CFI60 objective lenses which provide high numerical apertures and long working distances to deliver stunningly clear images.

#### High performance and quality optical accessories

Optical accessories achieve the same performance level as Nikon's inverted research microscope ECLIPSE Ti, providing exceptionally clear, sharp images.

Emboss contrast image (Top left): Two-cell stages derived from mesophyll protoplasts from *Nicotiana benthamiana* after 7 days of culture in liquid medium. (Objective: CFI S Plan Fluor ELWD 20XC)

Photo courtesy of: Dr. Jutta Schulze, Institute of Plant Biology, Braunschweig University of Technology



**TS2R**

Diascopic illumination model



**TS2R-FL**

Diascopic and epi-fluorescence illumination model

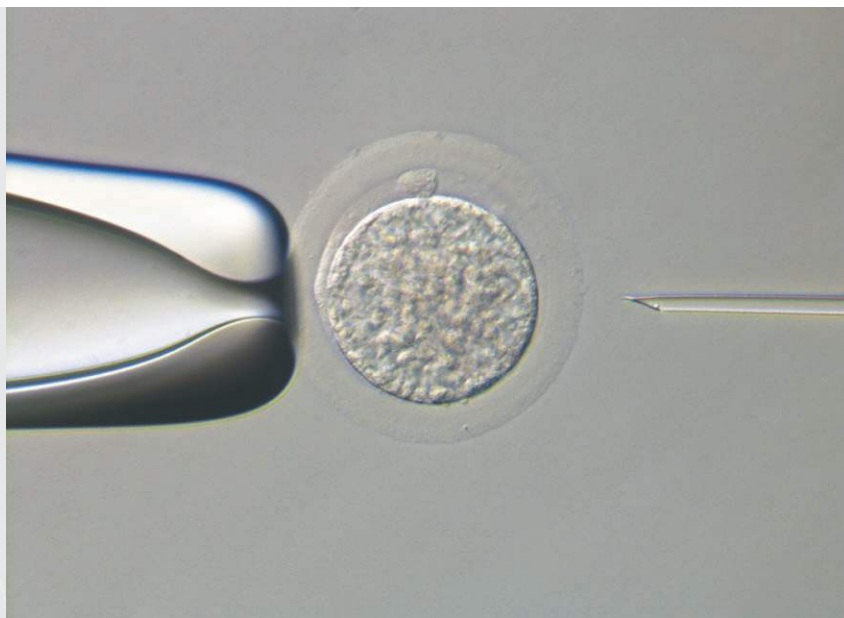

**Do more than before — DIA**

**Ts2R Ts2R-FL**

## Diascopic observations with enhanced quality

### High-intensity LED Eco-illumination

Nikon's LED Eco-illumination is environmentally friendly with its low power consumption and yet provides extremely bright illumination, suitable for phase contrast and DIC imaging. The built-in fly-eye lens ensures uniform brightness across the entire field of view. Furthermore, LED excitation has no unwanted UV component, thereby eliminating UV-mediated cell damage and improving cell survival rates during long-term imaging.

### Phase contrast observation

Phase contrast is an optical contrasting technique that typically utilizes a phase contrast objective lens and condenser annulus. The use of a high-intensity LED light source results in clear images even at high magnifications.

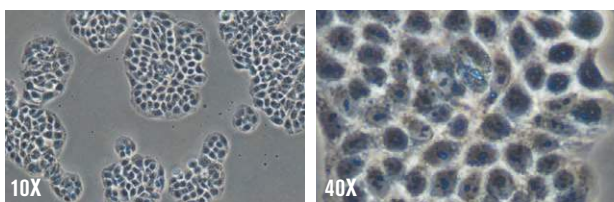

### Apodized Phase Contrast (APC) observation

APC observation is a type of phase contrast microscopy which minimizes unwanted halos in thick specimens. For example, APC technique provides clearer details of thick samples such as dividing cells.

### Nikon Advanced Modulation Contrast (NAMC)

NAMC provides high relief, DIC-like images of samples on plated on plastic dishes, which is not possible with DIC observation. Ts2R provides high-quality NAMC images like Nikon's inverted research microscope, ECLIPSE Ti.

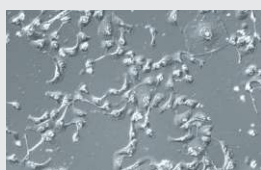

### Application



### New contrasting technique, "Emboss Contrast"

Nikon's new contrasting technique is compatible with both plastic and glass culture dishes. Unlike phase contrast or NAMC, Emboss Contrast does not require special objective lenses and therefore has minimal effect on epi-fluorescence observation. Emboss Contrast allows thick samples such as embryos to be easily observed in pseudo-three-dimensional image with great clarity.

Image courtesy of Hideaki Watanabe, Ph.D. and Hisataka Hasegawa, Ph.D.

### Spindle observation

Accurate observation of spindle bodies is easily attained with the Ts2R. The system offers finely detailed work without damaging the spindle body.



### Differential Interference Contrast (DIC) observation

DIC provides high-resolution pseudo-three dimensional images that have a shadow-cast appearance. New high-intensity LED illumination results in vivid DIC images even at high magnifications.



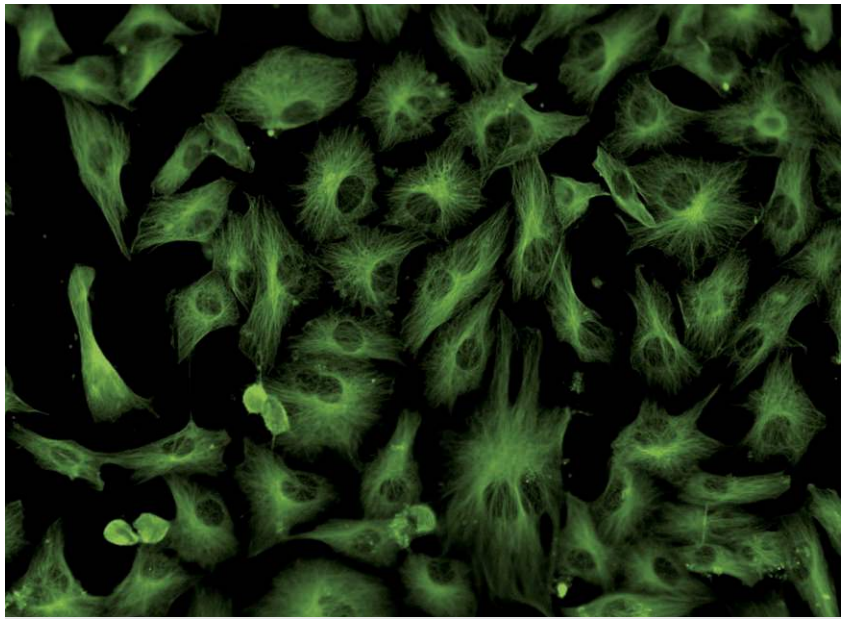

**Do more than before — FL**

**Ts2R-FL**

## Fluorescence images with uniform bright illumination

### Application

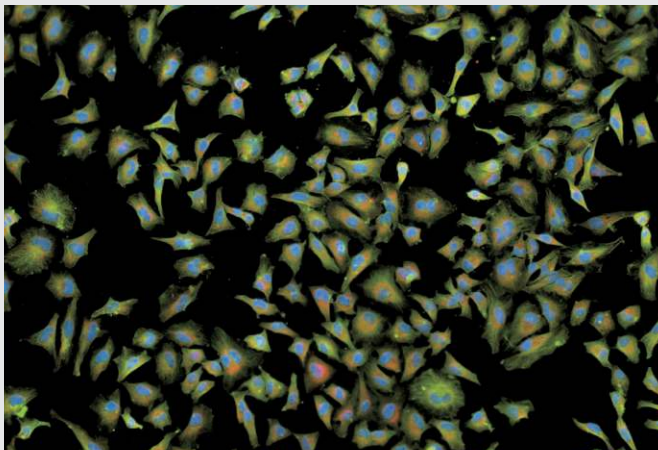

Overlapping image with three colors with use of Imaging Software NIS-Elements

#### Multicolor fluorescence observation

Using four different LEDs, multicolor fluorescence observation can be easily and efficiently achieved.

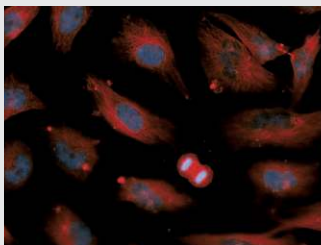

#### High signal-to-noise fluorescence imaging

Noise Terminator helps to capture vivid images.

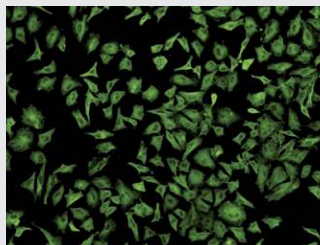

#### Clear, vivid observation across the entire field of view

The fly-eye lens delivers uniform brightness to the entire field of view.

#### Accurately reproduce illumination power every time

The illumination power previously defined by the user is replicated when the same wavelength is used again, thus eliminating the need for manual adjustment of light intensity when switching between wavelengths.



#### High S/N epi-fluorescence observation in bright rooms

The new Contrast Shield accessory (optional) blocks room light, providing an easy and cost-effective method for achieving high signal-to-noise fluorescence observation in a brightly lit laboratory.

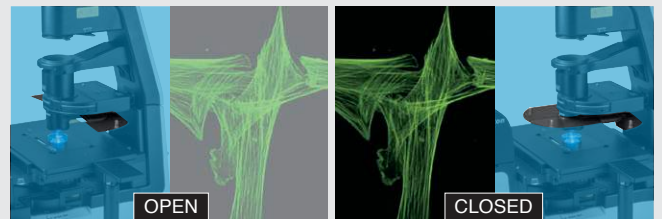

#### Fiber illumination

As an alternative to the built in LED system, an external light source can be utilized through the liquid light guide port to accommodate users who require custom lighting needs.



## Accessories

### ThermoPlate® TPI-TCSX

ThermoPlate® TPI-TCSX provides accurate and stable temperature control for the specimen from room temperature to 50 degrees Celsius. Proprietary treatment methods ensure that the glass surface of the Thermo Plate is breakage-free.

Manufacturer: Tokai Hit., Co. Ltd.

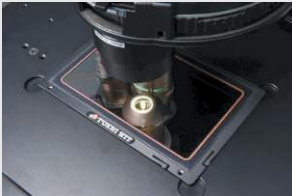

### Stage-top incubator

A stage-top incubation chamber can be utilized to accurately control temperature, humidity and CO<sub>2</sub> levels to maintain optimal cell health during long-term observation.

Manufacturer: Tokai Hit., Co. Ltd.

### Hydraulic micro manipulator system

This compact manipulation system features a suspension-type, soft-touch joy-stick. The hydraulic remote controls enable smooth, movement-free manipulation, minimizing needle deflection. Users can seamlessly switch between coarse and fine motion. Additionally, indicators on the coarse control mechanisms aid needle adjustments.

Manufacturer: Narishige Co., Ltd.



## Cameras for microscopes

All cameras of the digital sight series can be directly connected to a PC via a fast USB3.0 interface.

\*The optional camera port is required to attach the digital camera to the microscope.

### F-mount CMOS Camera

Microscope camera  
**DS-Ri2**

16.25 megapixel  
Color  
High-resolution



Capable of expressing images as is, this microscope digital camera offers high resolution, superior color reproduction and fast frame rate.

Frame rate	6 fps (4908 × 3264), 45 fps (1636 × 1088)
Max recordable pixels	4908 × 3264

Monochrome  
Microscope camera  
**DS-Qi2**

16.25 megapixel  
Monochrome  
Cooled



Capable of expressing images as is, this microscope digital camera offers high-sensitivity, and low noise imaging.

### C-mount CMOS Camera

Microscope camera  
**DS-Fi3**

5.9 megapixel  
Color  
High-resolution



A high-definition 5.9-megapixel color CMOS image sensor captures fine-textured images in faithful color. For image acquisition, NIS-Elements imaging software is required.

Frame rate	15 fps (2880 × 2048), 30 fps (1440 × 1024)
Max recordable pixels	2880 × 2048

Imaging software  
**NIS-Elements**  
Advanced Solutions for your Imaging World  
for a tablet PC **L**

Simply installing NIS-Elements L on a tablet PC enables setting and control of DS-Fi3/DS-Ri2 microscope cameras, live image display, and image acquisition.

\*For information about compatible tablet PCs, contact Nikon.



# System diagram

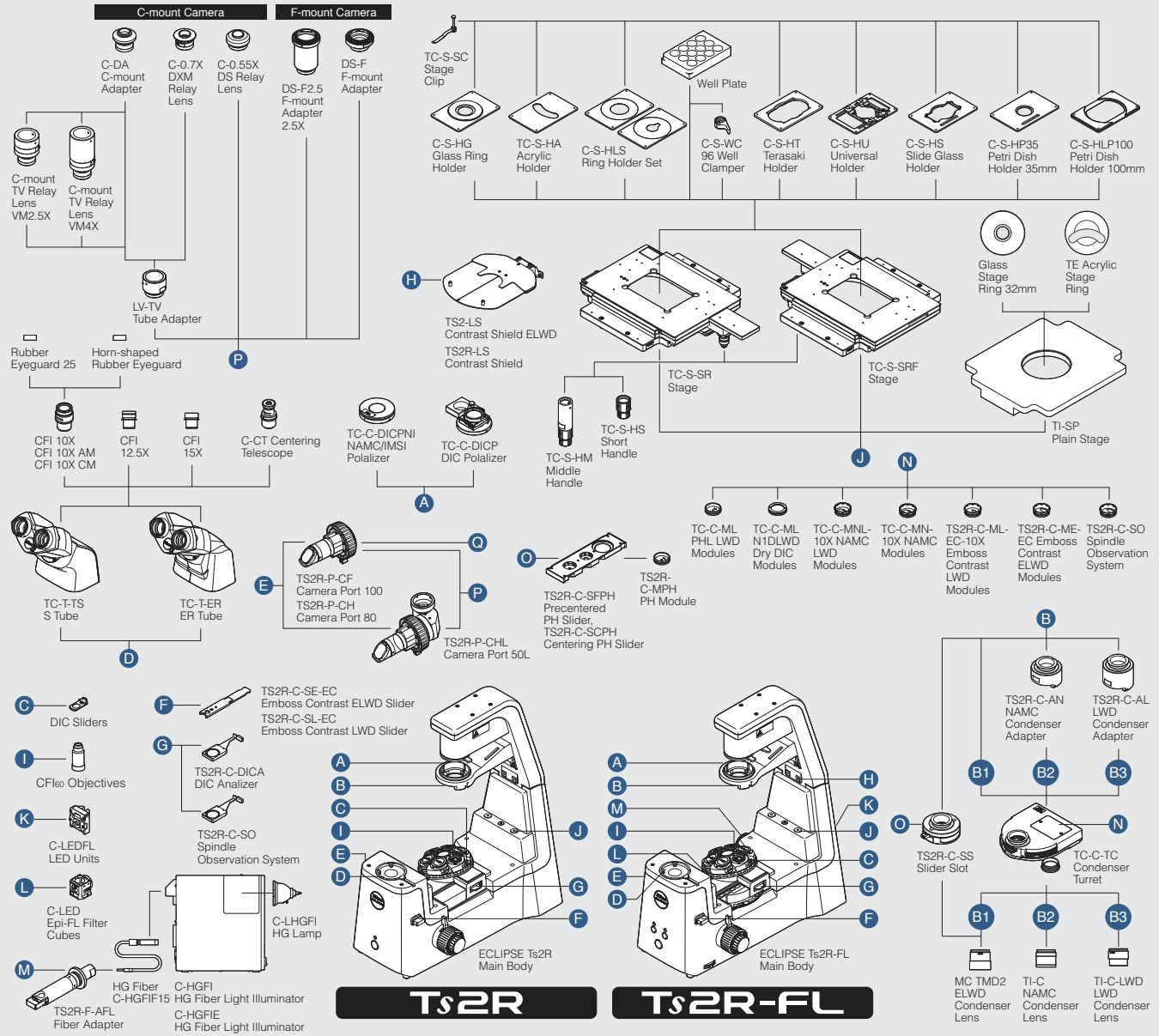

# Dimensions (Unit: mm)

## TS2R

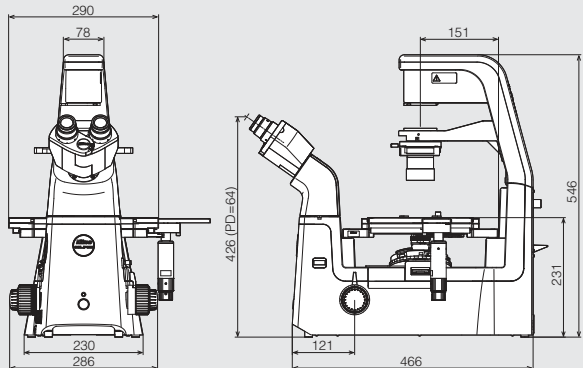

## TS2R-FL

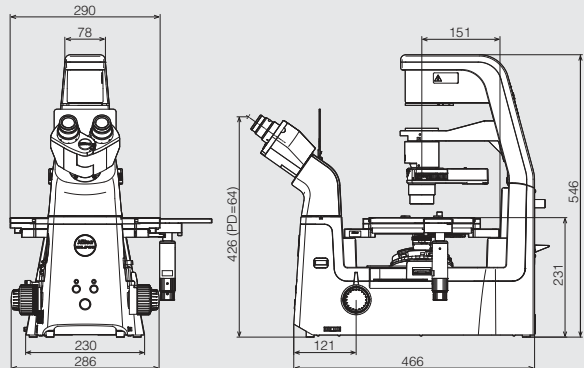

\*PD=Pupillary Distance

\*PD=Pupillary Distance

# Ts2R / Ts2R-FL Specifications

	Ts2R	Ts2R-FL
Optical System	CFI60 Infinity Optical System	
Observation method	Brightfield, Apodized Phase Contrast*1, Phase Contrast, Nikon Advanced Modulation Contrast*2, DIC, Emboss Contrast*3, Spindle Observation	Brightfield, Apodized Phase Contrast*1, Phase Contrast, Nikon Advanced Modulation Contrast*2, DIC, Emboss Contrast*3, Epi-Fluorescence, Spindle Observation
illumination	High luminescent white LED illuminator (Eco-illumination), Built-in Fly eye lens	
Diascopic illumination	—	
Episcopic illumination	LED illuminator, built-in Fly eye lens, Can be configured with up to 4 different fluorescence LED units; available wavelengths: 385, 455, 470, 505, 525, 560, 590, 625 nm	
Tube	<ul style="list-style-type: none"> <li>• Binocular tube: Inclination: 35 degree</li> <li>• Ergonomic tube: Inclination: 15-45 degree, Siedentopf type, Pupillary distance: 50-75 mm, Attachable camera port</li> </ul>	
Eyepiece(F.O.V.)	10X (22), 12.5X (16), 15X (14.5)	
Camera port (Eyepiece: Port)	• TS2R-P-CF 100:0 / 0:100 • TS2R-P-CH 100:0 / 20:80 • TS2R-P-CHL 100:0 / 50:50	
Focusing	Via nosepiece up/down movement, Stroke (manual): Up 8 mm, down 3 mm Coarse stroke: 5.0 mm per rotation, Fine stroke: 0.1 mm per rotation, Coarse motion torque adjustable, Refocusing mechanism mounted	
Nosepiece	Sextuple nosepiece, With DIC prism slots	
Condenser	Condenser turret, mount up to 7 modules: Phase Contrast, DIC, NAMC, IMSI, Emboss Contrast and ND for Bright Field Use with any one of ELWD condenser lens, LWD condenser lens and NAMC condenser lens	
Slider	<ul style="list-style-type: none"> <li>• Precentered or Centering PH Slider, 10X, 20X, 40X Objectives available for phase contrast</li> <li>• Emboss Contrast sliders (eyepiece-tube-side slider must be mounted), 10X, 20X, 40X, 60X objectives available for Emboss Contrast</li> </ul>	
Stage	<ul style="list-style-type: none"> <li>• Plain Stage, Stage Size 260(X)×300(Y) mm with 2 types of Stage Ring</li> <li>• Rectangular Mechanical Stage Stroke: 114(X)×73(Y) mm, Adjustable XY stroke limit, Accepts 8 types of micro-testplate, well clasper and stage clip</li> </ul>	
Holder	<ul style="list-style-type: none"> <li>• C-S-HP35 Petridish Holder 35 mm</li> <li>• C-S-HT Terasaki Holder for Terasaki holder and ø65 dish</li> <li>• C-S-HU Universal Holder for Terasaki plate holder, glass slide, ø35-65 dish and hemocytometer</li> <li>• C-S-HG Glass Ring Holder</li> <li>• C-S-HLP100 Petridish Holder 100 mm</li> <li>• C-S-HS Slide Glass Holder for glass slides, ø54 dish and hemocytometer</li> <li>• C-S-HLS Ring Holder Set</li> <li>• TC-S-HA Acrylic Holder</li> </ul>	
Epi Fluorescence attachment	—	Epi-fluorescence filter turret (with main body), Filter cubes with noise terminator mechanism Configure with up to 4 Epi-fluorescence filter cubes, one position is used during bright-field observation, Attachable Contrast Shield (optional; LWD, ELWD)
Dimensions	286(W)×466(D)×542(H) mm	286(W)×466(D)×542(H) mm
Weight (approx.)	17 kg	18 kg
Rated Voltage/Electric Current	100V-240 V, Less than 0.65 A	
Power Consumption	30W	

\*1 APC (Apodized Phase Contrast) is a type of phase contrast observation with reduced halo, thanks to Nikon's unique lens coating.

\*2 NAMC (Nikon Advanced Modulation Contrast) is Nikon's unique modulation contrast observation method which provides stereoscopic images similar to DIC observation, even with samples on plastic dishes.

\*3 Emboss contrast is Nikon's unique contrast observation method. It provides pseudo-three-dimensional images using focal illumination, which gives high contrast to samples.

## Related Products

### ECLIPSE Ts2/Ts2-FL

**Fits in Every Laboratory – Simple to Use & Compact**

The new Inverted Routine Microscope ECLIPSE Ts2 offers brilliantly clear images, enabling more efficient cell culture observation.

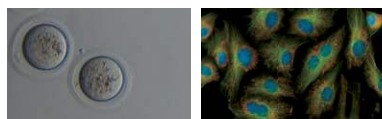

### ECLIPSE Ti2-U

**Inverted Research Microscope with an excellent manual model**

ECLIPSE Ti2-U provides an excellent base platform for accommodating a variety of research applications.



Specifications and equipment are subject to change without any notice or obligation on the part of the manufacturer. June 2019 ©2016-2019 NIKON CORPORATION

N.B. Export of the products\* in this brochure is controlled under the Japanese Foreign Exchange and Foreign Trade Law. Appropriate export procedures shall be required in case of export from Japan.

\*Products: Hardware and its technical information (including software)



**WARNING**

TO ENSURE CORRECT USAGE, READ THE CORRESPONDING MANUALS CAREFULLY BEFORE USING THE EQUIPMENT.



#### NIKON CORPORATION

Shinagawa Intercity Tower C, 2-15-3,  
Konan, Minato-ku, Tokyo 108-6290, Japan  
phone: +81-3-6433-3705 fax: +81-3-6433-3785  
<https://www.healthcare.nikon.com/>

ISO 14001 Certified  
for NIKON CORPORATION

#### NIKON INSTRUMENTS INC.

1300 Walt Whitman Road, Melville, N.Y. 11747-3064, U.S.A.  
phone: +1-631-547-8500; +1-800-52-NIKON (within the U.S.A. only)  
fax: +1-631-547-0306

<https://www.microscope.healthcare.nikon.com/>

#### NIKON INSTRUMENTS EUROPE B.V.

Tripolis 100, Burgenweeshuispad 101, 1076 ER Amsterdam, The Netherlands  
phone: +31-20-7099-0000 fax: +31-20-7099-298

[https://www.microscope.healthcare.nikon.com/en\\_EU/](https://www.microscope.healthcare.nikon.com/en_EU/)

#### NIKON INSTRUMENTS (SHANGHAI) CO., LTD.

CHINA phone: +86-21-6841-2050 fax: +86-21-6841-2060  
(Beijing branch) phone: +86-10-5831-2028 fax: +86-10-5831-2026  
(Guangzhou branch) phone: +86-20-3882-0550 fax: +86-20-3882-0580

#### NIKON CANADA INC.

CANADA phone: +1-905-602-9676 fax: +1-905-602-9653

#### NIKON FRANCE S.A.S.

FRANCE phone: +33-1-4516-45-16 fax: +33-1-4516-45-55

#### NIKON GMBH

GERMANY phone: +49-211-941-42-20 fax: +49-211-941-43-22

#### NIKON INSTRUMENTS S.p.A.

ITALY phone: +39-55-300-96-01 fax: +39-55-30-09-93

#### NIKON GMBH SWITZERLAND

SWITZERLAND phone: +41-43-277-28-67 fax: +41-43-277-28-61

#### NIKON UK LTD.

UNITED KINGDOM phone: +44-208-247-1717 fax: +44-208-541-4584

#### NIKON CEE GMBH

AUSTRIA phone: +43-1-972-6111 fax: +43-1-972-611-140

#### NIKON SINGAPORE PTE LTD.

SINGAPORE phone: +65-6559-3651 fax: +65-6559-3668

#### NIKON INSTRUMENTS KOREA CO., LTD.

KOREA phone: +82-2-2186-8400 fax: +82-2-555-4415