



Additional
cushions added
to Vicair O2
range



relief by air



Lifetime warranty is a unique Vicair service that applies to the latest generation of Vicair SmartCells.

We stand for the quality of these cells and therefore will always replace them in case some of them unexpectedly do not last a lifetime. Vicair Lifetime Warranty is an off-the-shelf service, no registration necessary. You can recognize the latest generation SmartCells by their black Vicair logo-print.

relief by air

IT ALL STARTS WITH INNOVATION

One simple question can change everything... *What if we could really control the air in a wheelchair cushion?* In 1993 this question instigated a wind of innovation through the world of rehabilitation. What started off as a light breeze has found its way into the hearts and wheelchairs of customers all over the world.

Today Vicair is a leading company in skin protection, seating and positioning. We are continuously working on developing, manufacturing and selling the most innovative solutions for people with seating challenges. Improving their comfort, safety and everyday functionality is our number one drive.

Everything we do still revolves around air, capturing its qualities with our SmartCell technology. We are constantly looking for ways to improve our users' quality of life and believe that innovation is key in the fight against pressure ulcers.

That is why we are dedicated to innovation in the following areas:

- **Materials**
Research and development of SmartCell and other materials to ensure optimal comfort, protection and usability.
- **Science in seating**
Developing tools for the ultimate wheelchair set-up addressing invisible causes of pressure sores.
- **Education**
Exchanging in-depth knowledge and practical insights with rehabilitation centres and therapists to improve seating and positioning together.
- **Quality**
Continuous development of new tools for quality control to secure carefree use at all time.

We will never think lightly of the everyday challenges our users face, but will do everything we can to make them a little lighter.

Because at Vicair, we care.

Vicair technology	4
Available covers.....	5
Cushion size.....	5

Seat cushions

Vicair Adjuster O2	7
Vicair Vector O2	8
Vicair Active O2	9
Vicair AllRounder O2	11
Vicair XXtra O2	12
Vicair Centre Relief O2	13
Vicair Multifunctional O2	14
Vicair Junior Vector O2	15
Vicair Liberty	16
Vicair Liberty Profile.....	17
Vicair Liberty TC.....	19

Back cushions

Vicair Liberty back	21
Vicair Anatomic back	22
Vicair Multifunctional back O2.....	23
Vicair Strap back.....	24

Mattresses

Vicair Mattress 415	25
Custom Made.....	27
Quality, Warranty and ISO	27

VICAIR TECHNOLOGY



The best medium for pressure redistribution is air. Unfortunately, there are a few drawbacks; air is unstable and it tends to leak. Vicair solved these issues when they created Vicair SmartCells.

The unique Vicair air-technology, which uses the small air-filled SmartCells, was developed in cooperation with the Amsterdam Rehabilitation Centre. It was awarded the Grand Prix at the 'Salon des Inventions' in Geneva, Switzerland. Vicair develops and produces its product line in the Netherlands for customers all over the world.

Lifetime Warranty

The latest generation Vicair SmartCells - printed with the black logo - come with lifetime warranty.

Unique combination of skin protection and positioning

When you sit on a Vicair wheelchair cushion, you are supported by hundreds of SmartCells. The layers of cells inside the cushion compartments move with so little friction that the effect resembles the behaviour of a viscous fluid, slowly adjusting to the shape of your body. Also, because SmartCells deform individually, they conform to your body's contours. The result is superior pressure redistribution.



On top of this, the design of the cushion compartments combined with the specific number of cells in them make the Vicair wheelchair cushion ultra stable and help prevent the

person sitting on it from sliding forward. As a result the cushion reduces shear forces to a bare minimum and helps to create and maintain an optimal, functional posture.



Ready for use

The Vicair cushion is ready for use straight out of the box.

Ease of use

Vicair SmartCell cushions are extremely user-friendly. The well balanced filling grade ensures that Vicair cushions are ready to use, but if you prefer, you can adjust the cushions to your personal positioning needs by adding or removing SmartCells.

Machine washable

You can easily machine wash the new Vicair O2 wheelchair cushions at 60°C.

The cushion requires hardly any maintenance; there is no need for a pump or any other accessories and once the cushion is set up, it doesn't require daily monitoring. The new Vicair O2 wheelchair cushions can even be easily machine washed at 60°C.

Not only are the Vicair wheelchair cushions extremely comfortable, but they are incredibly lightweight: on average weighing less than 0,8 kg each. This makes them the lightest high performance wheelchair cushions available by far.

AVAILABLE COVERS

CUSHION SIZE

A cushion cover has influence on the overall performance of a wheelchair cushion. Therefore the Vicair covers are made of high quality materials that enhance the performance of the Vicair cushion. Ensuring that you will experience maximum protection and comfort.

Vicair O2 Top Cover

Especially designed for the Vicair O2 cushion Range. This cover – similar to a cap – has a breathable outer layer and covers only the top part of the cushion. Leaving the bottom part open, allowing the cushion to continue to breathe and offering optimal ventilation and comfort.

The cover is ideal to help manage one of the main causes of pressure sores.

Comfair Cover

This breathable cover is made out of multi-dimensional stretch material, reducing pressure on bony prominences. The breathable fabric is designed for air transmission and heat dissipation.

Incotec Cover

A high quality fluid resistant cover made out of elastic material. Extremely usable in all situations (institutional and home use) where incontinence and hygiene is an issue.

Air Exchange Cover

Designed to use with the Vicair Liberty Profile. This cover is made of 3D mesh fabric, that makes it extra breathable and comfortable.

Reversible Cover

Fluid resistant material on one side and cool stretch fabric on the other side. Simply choose the outside of the cover that suits the situation. This cover fits a selected range of Vicair O2 wheelchair cushions.

It's not only the unique technique of the Vicair cushions that provides an optimal seating position. Next to the seat cushion a proper set-up of the wheelchair is extremely important.

Think of the adjustment of the foot plate, correct seating angle, right backrest height, but also the seat to floor height.

To get the correct size of wheelchair cushion, Vicair recommends to measure as follows:

The width (X) of the cushion and the wheelchair seat should match. When the cushion rests against armrests or side-guards, the width of a Vicair seat cushion may be up to 2,5 cm (1") wider.* The depth (Y) of the cushion and seat should match.

When ordering a Vicair cushion, first mention the width (X) of the cushion and then the depth (Y).

* Exception: The width of the Vicair Active O2 should always match the width of the wheelchair seat.

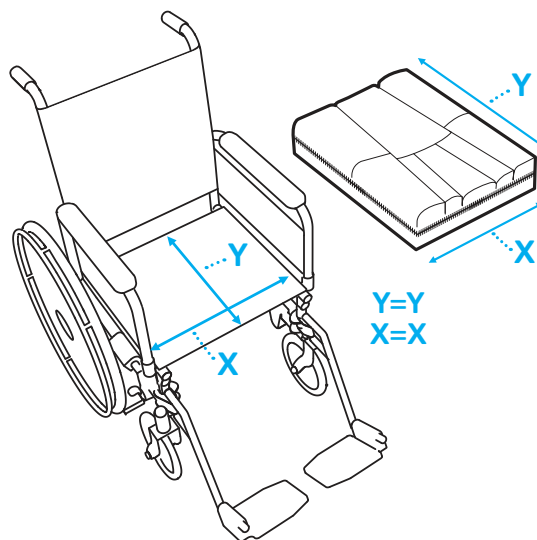

GENERAL TECHNICAL SPECIFICATIONS

Used materials	Latex free
Machine washable	60°C



VICAIR[®]

02

The Vicair O2 cushions tackle the hygiene issues caused by incontinence. The open structure of the Vicair O2 cushions allows the cushions to be easily washed in any washing machine. Without the need for a laundry bag, and without removing the SmartCells. These cushions are ideal for both institutional and home use, in situations where incontinence, temperature and humidity is an issue.



100% MACHINE WASHABLE
The cushion is, with the SmartCells inside, fully machine washable at 60°C



100% BREATHABLE
The open structure of the cushion provides optimal temperature and moisture regulation

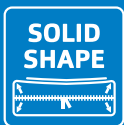

SOLID SHAPE
New design ensures that the cushion keeps its shape and volume, resulting in improved support and skin protection.



WIDE RANGE
Available in two heights;
145 standard sizes and custom sizes available on request

Highest level of skin protection

Exceptional stability & positioning

Easy to maintain; no inflation necessary

THE OPTIMAL CUSHION FOR WHEELCHAIR USERS WITH BODY ASYMMETRY

Pre-ischial bar limits sliding forward | converts shear into normal forces

Follows the body's contours for equal pressure distribution | support IT-coccyx area | managing pelvic asymmetry

Thigh support

Mid height zip closure for easy adjustment when client is seated | cushion keeps its shape, enhancing the user's skin protection

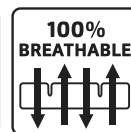

Individual solution for asymmetry

Minimizes sliding and shear forces

Optimal adjustment to the body's contours for equal pressure distribution

The Adjuster O2 is extremely suitable for use with asymmetric body contours and amputations. It automatically manages small obliquities and is individually adjustable to support more extreme asymmetry. When you're looking for a high comfort level, optimal skin protection and stability: the Adjuster O2 is always a safe choice. The design allows total immersion to equally redistribute pressure and limits sliding forward. 100% machine washable and breathable, for optimal hygiene and perfect temperature and moisture regulation. As a result the Adjuster O2 offers you optimal protection against skin breakdown.

PRODUCT PERFORMANCE

Skin protection / Anti decubitus	▲▲▲▲▲
Pressure redistribution	▲▲▲▲▲
Shear force reduction	▲▲▲▲▲
Microclimate control	▲▲▲▲▲
Impact & vibration damping	▲▲▲▲▲

Positioning

Lateral stability	▲▲▲▲▲△
Frontal stability	▲▲▲▲▲
Sliding reduction	▲▲▲▲▲
Allows manual adjustments	▲▲▲▲▲
Allows easy transfers	▲▲▲▲▲△

Maintenance & Safety

Durability	▲▲▲▲▲
Reliability	▲▲▲▲▲
Functionality when misused	▲▲▲▲▲△
Low maintenance level	▲▲▲▲▲
Level of hygiene	▲▲▲▲▲

Functionality & Application

Comfort	▲▲▲▲▲
Low cushion weight	▲▲▲▲▲
Available size range	▲▲▲▲▲
Maximum user weight	▲▲▲▲▲
Low seat to floor height	▲▲▲▲▲
Auto adjustments	▲▲▲▲▲△

USED WITH

Hemiplegia (CVA), amputations, foot propulsion, kyphosis, pelvic obliquity/ tilt/rotation, Spina Bifida, spasms, Fibrodysplasia Ossificans Progressiva (FOP)

TECHNICAL SPECIFICATIONS

Height	6 and 10 cm
Average weight	725 grams
Max. user weight	250 kg
Machine washable	60°C max.

CUSHION SIZES

Standard (Sizes >53 cm height 10 only)
On request

Inch	width										
	14	15	16	17	18	19	20	21	22	23	24
CM	35	38	40	43	45	48	50	53	55	58	60
14	35										
15	38										
16	40										
17	43										
18	45										
19	48										
20	50										
21	53										
22	55										
23	58										
24	60										

THE MOST STABLE CUSHION FOR WHEELCHAIR USERS

Ischial well - Two compartments
for superior pressure reduction in the IT-coccyx area & extra positioning possibilities

Trochanter support
firmer density to provide lateral stability | redistributes pressure to help create an ischial well



Front compartments provide leg alignment and stability | easily adjustable for individual positioning needs

Mid height zip closure for easy adjustment when client is seated | cushion keeps its shape, enhancing the user's skin protection

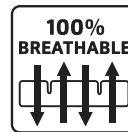

Nine adjustable compartments for optimal stability

Expanding the user's reach

Extra positioning of the thighs

The Vicair Vector O2 cushion offers enhanced stability to the wheelchair user. This results in improved functionality of the upper body and expands the reach of the user's arms. The cushion's unique compartment layout reduces pressure in the vulnerable area around the sitting bones and tailbone. The Vector O2 provides excellent leg guidance, optimal skin protection and extra pelvic stability.

The cushion is 100% machine washable and breathable, for optimal hygiene and perfect temperature and moisture regulation.

PRODUCT PERFORMANCE

Skin protection / Anti decubitus	▲▲▲▲▲
Pressure redistribution	▲▲▲▲▲
Shear force reduction	▲▲▲▲△
Microclimate control	▲▲▲▲▲
Impact & vibration damping	▲▲▲▲▲

Positioning

Lateral stability	▲▲▲▲▲
Frontal stability	▲▲▲▲▲
Sliding reduction	▲▲▲▲▲
Allows manual adjustments	▲▲▲▲▲
Allows easy transfers	▲▲▲▲△

Maintenance & Safety

Durability	▲▲▲▲▲
Reliability	▲▲▲▲▲
Functionality when misused	▲▲▲▲△
Low maintenance level	▲▲▲▲▲
Level of hygiene	▲▲▲▲▲

Functionality & Application

Comfort	▲▲▲▲▲
Low cushion weight	▲▲▲▲▲
Available size range	▲▲▲▲▲
Maximum user weight	▲▲▲▲▲
Low seat to floor height	▲▲▲▲▲
Auto adjustments	▲▲▲▲△

USED WITH

Spinal cord injuries, neuromuscular diseases, hypermobility syndrome, Ehlers Danlos Syndrome (EDS)

TECHNICAL SPECIFICATIONS

Height	6 and 10 cm
Average weight	725 grams
Max. user weight	250 kg
Machine washable	60°C max.

CUSHION SIZES

■ Standard (Sizes >53 cm height 10 only)
■ On request

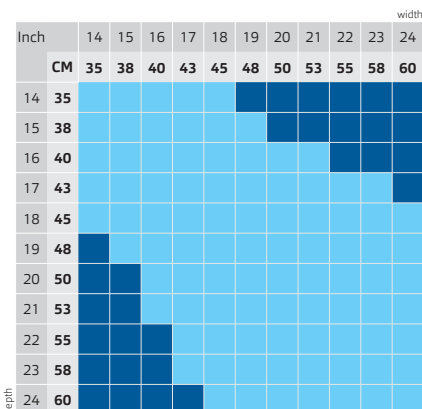

FOR THE ACTIVE WHEELCHAIR USER

Ischial well - Two compartments
for superior pressure reduction in the IT-coccyx area & extra positioning possibilities

Trochanter support
firmer density to provide lateral stability | redistributes pressure to help create an ischial well

Ergonomically-shaped foam
for easy transfers

SmartCell – Foam barrier
limits sliding forward

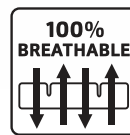
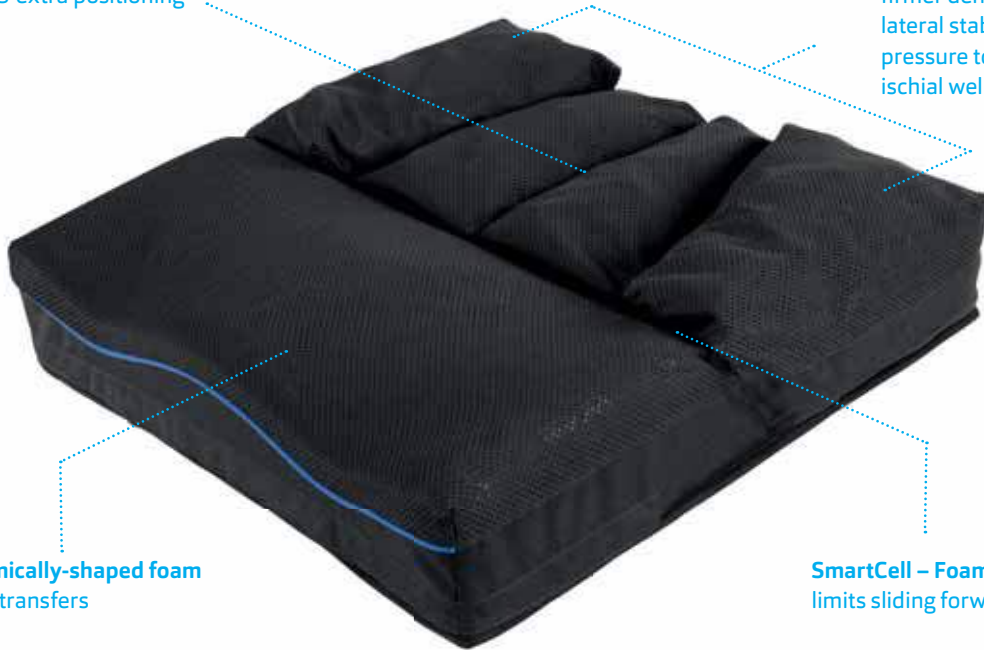

Perfect for users who transfer frequently

Excellent lateral and frontal stability

Features a nifty storage pouch for personal items

The Active O2 offers the unique combination of ergonomically shaped foam and Vicair SmartCells. The four rear SmartCell compartments provide a high level of comfort and skin protection, and reduce pressure on the sitting bones and tailbone area. The foam front makes transfers easy and feels steady and improves wheelchair handling. The foam inlay is protected by an easy-to-clean fluid-resistant liner. The rest of the cushion is 100% machine washable and breathable for optimal hygiene and perfect temperature & moisture regulation. The Active O2 has an easy accessible storage pouch for precious belongings (keys, phone, wallet). In short: everything you need to maintain your active lifestyle!

PRODUCT PERFORMANCE

Skin protection / Anti decubitus	▲▲▲▲▲
Pressure redistribution	▲▲▲▲▲
Shear force reduction	▲▲▲▲▲
Microclimate control	▲▲▲▲▲
Impact & vibration damping	▲▲▲▲▲

Positioning

Lateral stability	▲▲▲▲▲
Frontal stability	▲▲▲▲▲
Sliding reduction	▲▲▲▲▲
Allows manual adjustments	▲▲▲▲▲
Allows easy transfers	▲▲▲▲▲

Maintenance & Safety

Durability	▲▲▲▲▲
Reliability	▲▲▲▲▲
Functionality when misused	▲▲▲△△
Low maintenance level	▲▲▲▲▲
Level of hygiene	▲▲▲▲▲

Functionality & Application

Comfort	▲▲▲▲▲
Low cushion weight	▲▲▲▲△
Available size range	▲▲▲▲▲
Maximum user weight	▲▲▲▲▲
Low seat to floor height	▲▲▲▲▲
Auto adjustments	▲▲▲▲△

USED WITH

Spinal cord injuries, active users with a high transfer frequency

TECHNICAL SPECIFICATIONS

Height	6 and 9 cm
Average weight	1250 grams
Max. user weight	200 kg
Machine washable	60°C (without foam)

CUSHION SIZES

- Standard (Sizes >53 cm height 9 only)
- On request

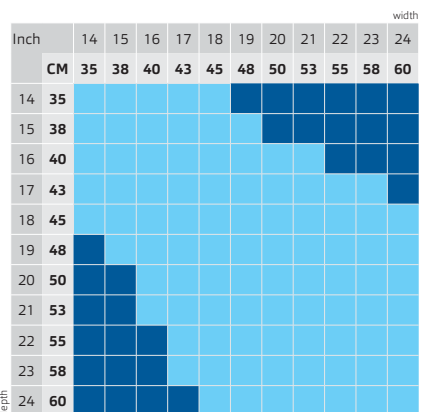



EXPLORE YOUR POSSIBILITIES

Ergonomically shaped back part for seamless fit to the shape of your lower back



Vicair SmartCells for skin-protection

Easily adjustable straps to provide comfort and to follow the body

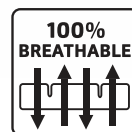

Stays with you during activities

Skin protection

Extremely light to support optimal mobility

Active as you are, not all of your activities require or allow the use of a wheelchair. In these situations the Vicair AllRounder O2 keeps you comfortable and helps to protect your skin. As it is easily buckled onto your body, it follows you around wherever you go.

Feel protected and secure during your sports and outdoor activities, when you sit in a normal chair or on any hard surface, or when you play on the ground. Afterwards you can simply put the entire AllRounder O2 in the washing machine, then hang it up to dry and you are ready for your next adventure. Experience the freedom and explore your possibilities!!

PRODUCT PERFORMANCE

Skin protection / Anti decubitus	▲▲▲▲△
Pressure redistribution	△△△△△
Shear force reduction	△△△△△
Microclimate control	▲▲▲▲▲
Impact & vibration damping	▲▲▲▲△

Positioning

Positioning	△△△△△
Lateral stability	△△△△△
Frontal stability	△△△△△
Sliding reduction	△△△△△
Allows manual adjustments	△△△△△
Allows easy transfers	△△△△△

Maintenance & Safety

Durability	▲▲▲▲▲
Reliability	▲▲▲▲▲
Functionality when misused	△△△△△
Low maintenance level	▲▲▲▲△
Level of hygiene	▲▲▲▲▲

Functionality & Application

Comfort	▲▲▲▲▲
Low cushion weight	▲▲▲▲▲
Available size range	▲▲▲▲▲
Maximum user weight	▲▲▲▲▲
Low seat to floor height	▲▲▲▲▲
Auto adjustments	△△△△△

USED WITH

Activities outside of the wheelchair | When seated on hard surfaces for long periods in time.

TECHNICAL SPECIFICATIONS

Height	n.a.
Average weight	800 grams
Max. user weight	100 kg
Machine washable	60°C max.

CUSHION SIZE

Small	< 38 cm
Medium	38 – 42,5 cm
Large	43 – 48 cm

Determining the correct hip width
 Measure the width of your hips to check which size matches the size of your body. When seated, hold a tape measure horizontally above the widest point of your upper legs, closely against the front of your hips. Do not follow your leg contours, keep the tape measure straight. Measure from A to B (or B to A). Choose the larger size if the measured size is in between two sizes.

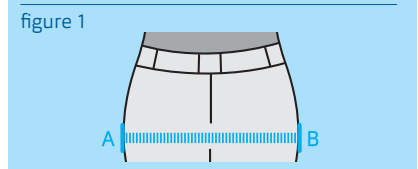

ESPECIALLY DEVELOPED FOR BARIATRICS

Pre-ischial bar limits sliding forward | converts shear into normal forces

Follows the body's contours for equal pressure distribution | support IT-coccyx area | managing pelvic asymmetry



Thigh support

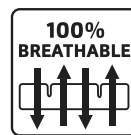

User weight up to 500kg

Shaped like the Vicair Adjuster O2

Wider size range than other Vicair products

The Vicair XXtra O2 is a wheelchair cushion especially developed for bariatrics. The compartments are filled with bigger SmartCells, offering individuals with a weight of up to 500 kg optimal protection against skin breakdown. The design, based on the Vicair Adjuster O2, combines excellent stability and positioning possibilities with a very high level of comfort.

100% machine washable and breathable, for optimal hygiene and perfect temperature and moisture regulation. The cushion automatically manages small pelvic obliquities, but can be individually adjusted to support more extreme asymmetry.

Despite the large size, the Vicair XXtra O2 is extremely lightweight!

PRODUCT PERFORMANCE

Skin protection / Anti decubitus	▲▲▲▲▲
Pressure redistribution	▲▲▲▲▲
Shear force reduction	▲▲▲▲▲
Microclimate control	▲▲▲▲▲
Impact & vibration damping	▲▲▲▲▲

Positioning

Lateral stability	▲▲▲▲▲△
Frontal stability	▲▲▲▲▲
Sliding reduction	▲▲▲▲▲
Allows manual adjustments	▲▲▲▲▲
Allows easy transfers	▲▲▲▲▲△

Maintenance & Safety

Durability	▲▲▲▲▲
Reliability	▲▲▲▲▲
Functionality when misused	▲▲▲▲▲△
Low maintenance level	▲▲▲▲▲
Level of hygiene	▲▲▲▲▲

Functionality & Application

Comfort	▲▲▲▲▲
Low cushion weight	▲▲▲▲▲
Available size range	▲▲▲▲▲
Maximum user weight	▲▲▲▲▲
Low seat to floor height	▲▲▲▲▲△
Auto adjustments	▲▲▲▲▲△

USED WITH

Obesity, Hemiplegia (CVA), amputations, foot propulsion, kyphosis, pelvic obliquity/tilt/rotation, Spina Bifida, spasms, Fibrodysplasia Ossificans Progressiva (FOP)

TECHNICAL SPECIFICATIONS

Height	10 cm
Average weight	900 grams
Max. user weight	500 kg
Machine washable	60°C max.

CUSHION SIZES

- Standard
- On request

Inch	width					
	22	24	26	28	30	
CM	55	60	65	70	75	
18	45					
20	50					
22	55					
24	60					
26	65					
28	70					
30	75					

OFFLOADING PRESSURE IN THE HIGH RISK AREA

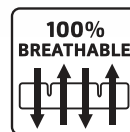

For completely offloading of the rectal area

Adjustable non-contact area

Stable positioning

The Vicair Centre Relief O2 is the best choice if you need to completely offload the rectum perineum and coccyx area. By simply removing SmartCells from the centre circle compartment you create a non-contact area. This important feature makes a great difference for persons with (for instance) localized deep pressure ulcers, rectum or tailbone problems. Or after perineal surgery.

100% machine washable and breathable, for optimal hygiene and perfect temperature and moisture regulation.

The Vicair Centre Relief O2 helps you to sit comfortably and safe, even in the most painful situations.

PRODUCT PERFORMANCE

Skin protection / Anti decubitus	▲▲▲▲△
Pressure redistribution	▲▲▲▲▲
Shear force reduction	▲▲▲▲△
Microclimate control	▲▲▲▲▲
Impact & vibration damping	▲▲▲▲▲

Positioning	▲▲▲▲△
Lateral stability	▲▲▲▲△
Frontal stability	▲▲▲▲△
Sliding reduction	▲▲▲▲△
Allows manual adjustments	▲▲▲▲▲
Allows easy transfers	▲▲▲▲△

Maintenance & Safety	▲▲▲▲△
Durability	▲▲▲▲▲
Reliability	▲▲▲▲▲
Functionality when misused	▲▲▲▲△
Low maintenance level	▲▲▲▲▲
Level of hygiene	▲▲▲▲▲

Functionality & Application	▲▲▲▲△
Comfort	▲▲▲▲▲
Low cushion weight	▲▲▲▲▲
Available size range	▲▲▲▲△
Maximum user weight	▲▲▲▲▲
Low seat to floor height	▲▲▲▲▲
Auto adjustments	▲▲▲▲△

USED WITH

Rectum problems, tailbone problems, localized deep pressure ulcers, after perineal surgery or difficult childbirth

TECHNICAL SPECIFICATIONS

Height	10 cm
Average weight	750 grams
Max. user weight	250 kg
Machine washable	60°C max.

CUSHION SIZES

- Standard
- On request

Inch	width										
	14	15	16	17	18	19	20	21	22	23	24
CM	35	38	40	43	45	48	50	53	55	58	60
14	35										
15	38										
16	40										
17	43										
18	45										
19	48										
20	50										
21	53										
22	55										
23	58										
24	60										

COMFORT AND SKIN PROTECTION IN A TILT-IN-SPACE WHEELCHAIR

Pre-ischial bar limits sliding forward | converts shear into normal forces

Longer compartments to fit into tilt-in-space chairs | follow the body's contours for equal pressure distribution | support IT-coccyx area | managing pelvic asymmetry

Thigh support

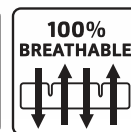

Ideal for use in tilt-in-space chair with adjustable seat depth

Vicair Adjuster O2 design with deeper rear end compartments

Optimal adjustment to the body's contours for equal pressure distribution

The Vicair Multifunctional O2 seat cushion is developed to use in a tilt-in-space wheelchair with adjustable seat depth. It provides a high level of comfort, optimal skin protection and stability. The design allows total immersion to redistribute pressure equally, and it keeps you comfortably positioned and supported. 100% machine washable and breathable, for optimal hygiene and perfect temperature and moisture regulation. A safe and reliable solution, especially when used together with the Vicair Multifunctional O2 back cushion.

PRODUCT PERFORMANCE

<u>Skin protection / Anti decubitus</u>	▲▲▲▲▲
Pressure redistribution	▲▲▲▲▲
Shear force reduction	▲▲▲▲▲
Microclimate control	▲▲▲▲▲
Impact & vibration damping	▲▲▲▲▲

<u>Positioning</u>	▲▲▲▲▲
Lateral stability	▲▲▲▲▲△
Frontal stability	▲▲▲▲▲
Sliding reduction	▲▲▲▲▲
Allows manual adjustments	▲▲▲▲▲
Allows easy transfers	▲▲▲▲▲△

<u>Maintenance & Safety</u>	▲▲▲▲▲
Durability	▲▲▲▲▲
Reliability	▲▲▲▲▲
Functionality when misused	▲▲▲▲▲△
Low maintenance level	▲▲▲▲▲
Level of hygiene	▲▲▲▲▲

<u>Functionality & Application</u>	▲▲▲▲▲
Comfort	▲▲▲▲▲
Low cushion weight	▲▲▲▲▲
Available size range	▲▲▲▲▲
Maximum user weight	▲▲▲▲▲
Low seat to floor height	▲▲▲▲▲△
Auto adjustments	▲▲▲▲▲△

USED WITH

Neuromuscular diseases, Rheumatism, Quadriplegia, pain relief, in a geriatric environment

TECHNICAL SPECIFICATIONS

Height	8 cm
Average weight	850 grams
Max. user weight	250 kg
Machine washable	60°C max.

CUSHION SIZES

cm	inches
37x52	14¾x20¾
40x52	16x20¾
45x52	18x20¾
50x52	20x20¾

Sizes in width x depth

THE OPTIMAL PEDIATRIC CUSHION

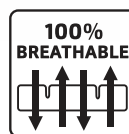
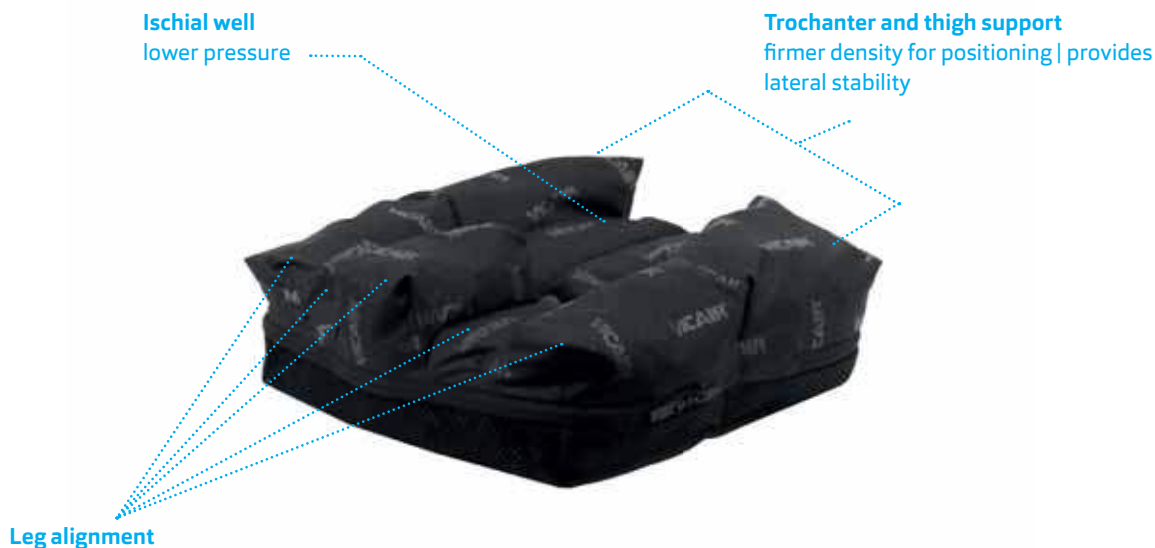

Especially designed for children

Filled with small-sized SmartCells for optimal pressure redistribution

Built to provide carefree mobility

The Vicair Junior Vector 02 is designed for the child's physique. Based on the Vicair Vector 02 and filled with small-sized junior SmartCells, it provides optimal pressure redistribution and comfort. You will appreciate the excellent stability and positioning possibilities of this cushion. It offers a solution, for instance, for children with muscle disorders and spasms. 100% machine washable and breathable, for optimal hygiene and perfect temperature and moisture regulation. The Vicair Junior Vector 02 keeps the child comfortable, safe and protected during its daily adventures.

PRODUCT PERFORMANCE

Skin protection / Anti decubitus	▲▲▲▲△
Pressure redistribution	▲▲▲▲▲
Shear force reduction	▲▲▲▲△
Microclimate control	▲▲▲▲▲
Impact & vibration damping	▲▲▲▲▲

Positioning

Lateral stability	▲▲▲▲▲
Frontal stability	▲▲▲▲▲
Sliding reduction	▲▲▲▲▲
Allows manual adjustments	▲▲▲▲▲
Allows easy transfers	▲▲▲▲△

Maintenance & Safety

Durability	▲▲▲▲▲
Reliability	▲▲▲▲▲
Functionality when misused	▲▲▲▲△
Low maintenance level	▲▲▲▲▲
Level of hygiene	▲▲▲▲▲

Functionality & Application

Comfort	▲▲▲▲▲
Low cushion weight	▲▲▲▲▲
Available size range	▲▲▲▲▲
Maximum user weight	▲▲▲▲▲
Low seat to floor height	▲▲▲▲▲
Auto adjustments	▲▲▲▲△

USED WITH

Spasms, muscle disorders

TECHNICAL SPECIFICATIONS

Height	9 cm
Average weight	450 grams
Max. user weight	100 kg
Machine washable	60°C max.

CUSHION SIZES

- Standard
- On request

		width				
Inch		10	11	12	13	14
CM		25	28	30	33	35
depth	10	Standard	On request	On request	On request	On request
	11	Standard	On request	On request	On request	On request
	12	Standard	On request	On request	On request	On request
	13	Standard	On request	On request	On request	On request
	14	Standard	On request	On request	On request	On request

ULTRA-LIGHTWEIGHT, EASY TO USE AND COMFORTABLE

Compartment barrier gently limits sliding forward

Equal pressure distribution on the seating surface

Auto-adjusting valve

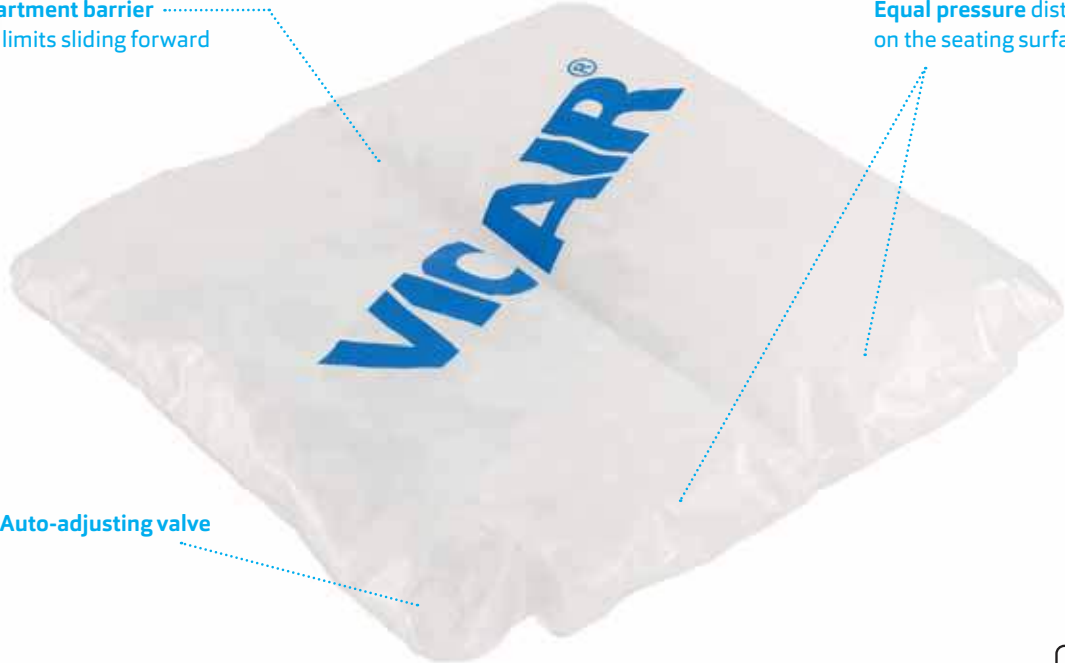

Air valve automatically adapts the cushion to your body shape and weight

Two compartment layout limits sliding

Easy to clean and disinfect

The Vicair Liberty is an easy to use and comfortable (wheelchair) cushion. It is designed for users who require comfort in combination with a low to medium level of support and pressure ulcer prevention. The cushion is ready-for-use, rain proof and with two compartments it provides an even pressure distribution. This makes it an ideal cushion for occasional use in a large variety of situations.

This Vicair cushion is extremely lightweight.

PRODUCT PERFORMANCE

Skin protection / Anti decubitus	▲▲▲▲△
Pressure redistribution	▲▲▲▲△
Shear force reduction	▲▲▲▲△
Microclimate control	▲▲▲▲△
Impact & vibration damping	▲▲▲▲△

Positioning

Lateral stability	▲▲▲▲△
Frontal stability	▲▲▲▲△
Sliding reduction	▲▲▲▲△
Allows manual adjustments	▲▲▲▲△
Allows easy transfers	▲▲▲▲△

Maintenance & Safety

Durability	▲▲▲▲△
Reliability	▲▲▲▲△
Functionality when misused	▲▲▲▲▲
Low maintenance level	▲▲▲▲▲
Level of hygiene	▲▲▲▲▲

Functionality & Application

Comfort	▲▲▲▲△
Low cushion weight	▲▲▲▲▲
Available size range	▲▲▲▲△
Maximum user weight	▲▲▲▲▲
Low seat to floor height	▲▲▲▲▲
Auto adjustments	▲▲▲▲△

USED WITH

Osteoarthritis/arthritis, rheumatism, spondylitis, pain relief, mobility problems, in a geriatric environment.

TECHNICAL SPECIFICATIONS

Height	5 cm
Average weight	350 grams
Max. user weight	150 kg

CUSHION SIZES

- Standard
- Not available

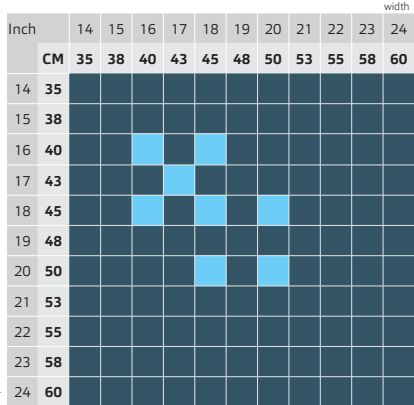

LIGHTWEIGHT POSITIONING SUPPORT, COMFORTABLE AND EASY TO USE



More stability thanks to the shape of the integrated foam base

Air valves automatically adapt the cushion to your body shape and weight

Comfortable and rain proof

The Vicair Liberty Profile is an easy to use and comfortable wheelchair cushion for occasional use. Designed for comfort in combination with a low to medium level of support and pressure ulcer prevention. The Vicair Liberty Profile has an integrated foam base with a semi-circle cut out at the location of the sitting bones. The combination of SmartCells and foam-base supports pelvic stability and offers a high level of comfort in the IT-Coccyx zone. The added second valve allows an even easier automatic adaption to the body shape. This Vicair cushion is ready-for-use, rain proof and very lightweight.

PRODUCT PERFORMANCE

Skin protection / Anti decubitus	▲▲▲▲△
Pressure redistribution	▲▲▲▲△
Shear force reduction	▲▲▲▲△
Microclimate control	▲▲▲▲△
Impact & vibration damping	▲▲▲▲△

Positioning	▲▲▲▲△
Lateral stability	▲▲▲▲△
Frontal stability	▲▲▲▲△
Sliding reduction	▲▲▲▲△
Allows manual adjustments	▲▲▲▲△
Allows easy transfers	▲▲▲▲△

Maintenance & Safety	▲▲▲▲△
Durability	▲▲▲▲△
Reliability	▲▲▲▲△
Functionality when misused	▲▲▲▲▲
Low maintenance level	▲▲▲▲▲
Level of hygiene	▲▲▲▲▲

Functionality & Application	▲▲▲▲▲
Comfort	▲▲▲▲▲
Low cushion weight	▲▲▲▲▲
Available size range	▲▲▲▲△
Maximum user weight	▲▲▲▲▲
Low seat to floor height	▲▲▲▲▲
Auto adjustments	▲▲▲▲△

USED WITH

Osteoarthritis/arthritis, rheumatism, spondylitis, pain relief, mobility problems, in a geriatric environment

TECHNICAL SPECIFICATIONS

Height	6 cm
Average weight	600 grams
Max. user weight	150 kg

CUSHION SIZES

- Standard
- Not available

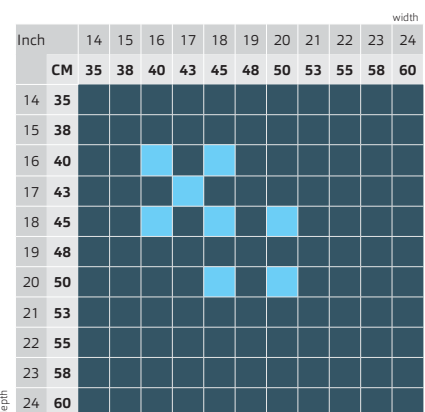



VICAIR

FOR A COMFORTABLE TOILET VISIT

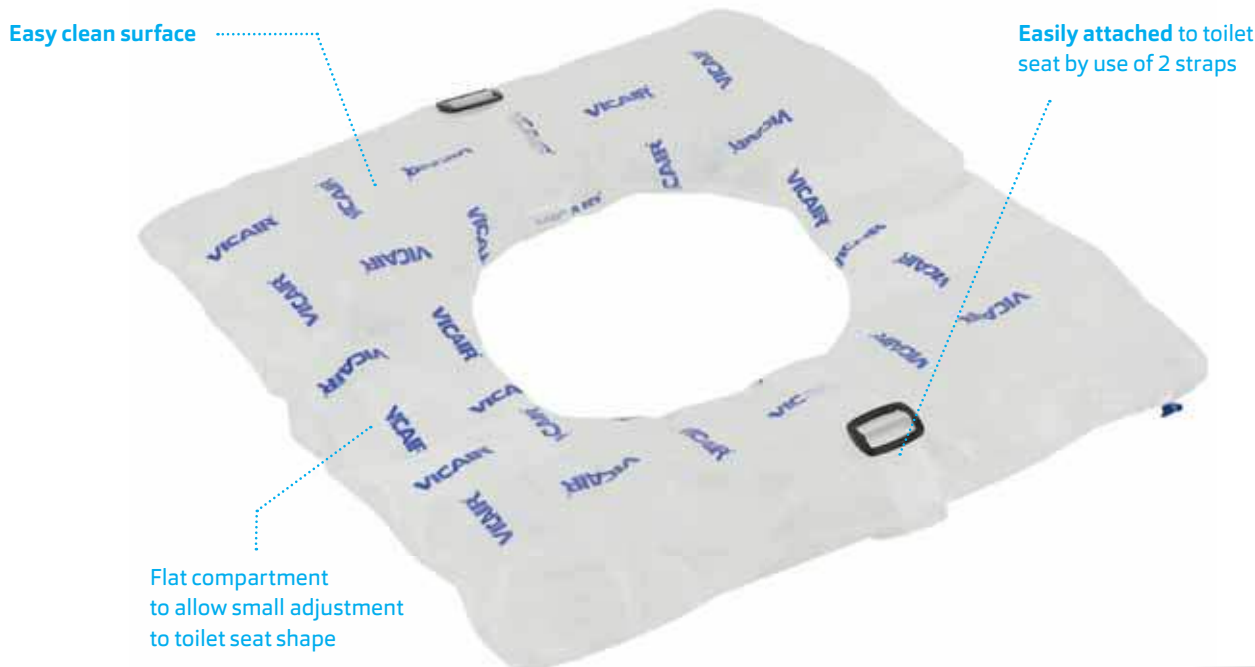

Changes the hard toilet seat into a comfortable seating surface

Straps for an easy fix onto the toilet seat

Watertight which makes it easy to clean and disinfect

The Vicair Liberty TC is a toilet seat cushion that offers comfort and skin protection during toilet visits. It is easy to install: simply strap the lightweight cushion onto the toilet seat. And of course it is easy to clean and disinfect.

PRODUCT PERFORMANCE

Skin protection / Anti decubitus	▲▲▲▲▲
Pressure redistribution	▲▲▲▲▲
Shear force reduction	△△△△△
Microclimate control	△△△△△
Impact & vibration damping	△△△△△

Positioning	▲▲△△△
Lateral stability	△△△△△
Frontal stability	△△△△△
Sliding reduction	△△△△△
Allows manual adjustments	△△△△△
Allows easy transfers	▲▲△△△

Maintenance & Safety	▲▲▲▲△
Durability	▲▲▲▲△
Reliability	▲▲▲▲△
Functionality when misused	▲▲△△△
Low maintenance level	▲▲▲▲▲
Level of hygiene	▲▲▲▲▲

Functionality & Application	▲▲▲△△
Comfort	▲▲▲△△
Low cushion weight	▲▲▲▲▲
Available size range	▲▲▲△△
Maximum user weight	▲▲▲▲▲
Low seat to floor height	▲▲▲▲▲
Auto adjustments	△△△△△

USED WITH

(Extremely) thin persons, elderly people, paraplegia, bladder-spasms, bowel management (enemas) after Spinal Cord Injuries

TECHNICAL SPECIFICATIONS

Height	5 cm
Average weight	350 grams
Max. user weight	150 kg

CUSHION SIZES

cm	inches
43x43	17x17
50x45	20x18

Sizes in width x depth

The VICAIR logo is displayed in a bold, white, sans-serif font. The letters 'V', 'I', 'C', 'A', and 'I' are significantly larger than the 'R'. A registered trademark symbol (®) is positioned to the upper right of the 'R'. The logo is set against a dark blue background that is part of a larger graphic design featuring a blue triangle and a dark grey fabric with the brand name printed on it.

SOFT BACK

Extremely lightweight

Easy to apply

Easy to set up

**Highly adjustable,
so better positioning
options and comfort**

Little to no maintenance

THE BEST BACK SUPPORT FOR USERS OF MANUAL TILT-IN-SPACE WHEELCHAIRS AND POWERCHAIRS

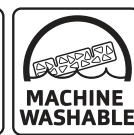
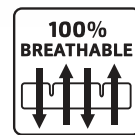

Supporting different postures

Follows the human spine alignment

Optimal pressure redistribution

Excellent pressure redistribution, comfort and support make this back support cushion perfect for use in a large variety of situations. It can be used in several types of back systems and in tilt-in-space chairs with adjustable seat depth. The cushion is easily fixed onto the solid back support by use of hook and loop strips. With the Vicair Back Connector the Multifunctional O2 Back can also be used in tension adjustable backs such as the Vicair Strap Back. Although it automatically adapts to the body's contours, the cushion can also be adjusted for optimal positioning, while the user is still leaning against the cushion. 100% machine washable and breathable, for optimal hygiene and perfect temperature and moisture regulation.

PRODUCT PERFORMANCE

Skin protection / Anti decubitus	▲▲▲▲△
Pressure redistribution	▲▲▲▲▲
Shear force reduction	▲▲▲▲△
Microclimate control	▲▲▲▲▲
Impact & vibration damping	▲▲▲▲▲

Positioning

Lateral stability	▲▲▲▲△
Frontal stability	▲▲▲▲△
Sliding reduction	▲▲▲▲▲
Allows manual adjustments	▲▲▲▲▲
Allows easy transfers	▲▲▲▲△

Maintenance & Safety

Durability	▲▲▲▲▲
Reliability	▲▲▲▲▲
Functionality when misused	▲▲▲▲△
Low maintenance level	▲▲▲▲▲
Level of hygiene	▲▲▲▲▲

Functionality & Application

Comfort	▲▲▲▲▲
Low cushion weight	▲▲▲▲▲
Available size range	▲▲▲▲▲
Maximum user weight	▲▲▲▲▲
Low seat to floor height	n.a.
Auto adjustments	▲▲▲▲△

USED WITH

Neuromuscular diseases, Scoliosis, Kyphosis, Lordosis, Gibbus, Quadriplegia, pain relief, in a geriatric environment

TECHNICAL SPECIFICATIONS

Length	36-60 cm
Average weight	975 grams
Max. user weight	150 kg
Machine washable	60°C max.
Loss of seat depth	3 cm

CUSHION SIZES

- Standard
- On request

length	width												
	Inch	14½	14¾	16	16½	17	18	18½	19	20	21½	23	24
CM	36	37	40	41	43	45	46	48	50	54	58	60	
14½	36												
15	38												
16	40												
17	43												
18	45												
19	48												
20	50												
20¾	52												
21½	54												
23	58												
24	60												

OPTIMAL POSITIONING AND SUPPORT FOR EVERY INDIVIDUAL MANUAL WHEELCHAIR USER



**PRESSURE
ULCER
TREATMENT**

Optimal positioning through a combination of SmartCells and Strap back

Offloading the spinal column

Dynamically moulds to the individual's back contours

The Vicair Anatomic back is a highly comfortable universal back support, that enables optimal positioning and high quality pressure redistribution. Ready for use, as it dynamically moulds to the contours of the user's back, but also allowing a large variety of individual adjustments. Adjustments can be made with the client still leaning against the cushion. The lightweight cushion is used in combination with the easy-install Vicair Strap back and can be used in wheelchairs without a back support plate. It is extremely suitable to use with (extreme) Scoliosis. The Anatomic back follows asymmetric body contours and keeps you safe and stable.

PRODUCT PERFORMANCE

Skin protection / Anti decubitus	▲▲▲▲△
Pressure redistribution	▲▲▲▲▲
Shear force reduction	▲▲▲▲△
Microclimate control	▲▲▲△△
Impact & vibration damping	▲▲▲▲△

Positioning

Lateral stability	▲▲▲▲△
Frontal stability	▲▲▲▲△
Sliding reduction	▲▲▲▲▲
Allows manual adjustments	▲▲▲▲▲
Allows easy transfers	▲▲▲▲△

Maintenance & Safety

Durability	▲▲▲▲▲
Reliability	▲▲▲▲▲
Functionality when misused	▲▲▲▲△
Low maintenance level	▲▲▲▲△
Level of hygiene	▲▲▲▲△

Functionality & Application

Comfort	▲▲▲▲▲
Low cushion weight	▲▲▲▲▲
Available size range	▲▲▲▲▲
Maximum user weight	▲▲▲▲▲
Low seat to floor height	n.a.
Auto adjustments	▲▲▲▲△

USED WITH

Scoliosis, Kyphosis, Neuromuscular diseases, Spinal cord injuries, pressure sore on back/spine/shoulder, pain relief

TECHNICAL SPECIFICATIONS

Length	32-56 cm
Average weight	900 grams
Max. user weight	150 kg
Loss of seat depth	3 cm

CUSHION SIZES

- Standard
- On request

Inch	width				
	12	14	16	18	20
CM	30	35	40	45	50
12½	32	▲	▲	▲	▲
16	40	▲	▲	▲	▲
19	48	▲	▲	▲	▲
22½	56	▲	▲	▲	▲

EXCELLENT FOR MANUAL WHEELCHAIR USERS WITH BACK PAIN



Air technology inside for comfort, support and pressure redistribution



Combine with easy-install adjustable Vicair Strap back for positioning and balance



Easy to apply on a standard (folding) wheelchair
Automatically adapts to change, including reclining back support
Excellent for users with back pain

The Vicair Liberty back cushion changes your wheelchair back from standard into extremely comfortable. Combined with the easy-install Vicair Strap back, the cushion offers perfect pain relief and follows and gently supports postural or anatomical anomalies. This extremely lightweight back cushion is easy in transport, as the wheelchair can still be folded when the cushion is attached to it. An easy solution to create comfort and support.

PRODUCT PERFORMANCE

Skin protection / Anti decubitus	▲▲▲▲△
Pressure redistribution	▲▲▲▲△
Shear force reduction	▲▲▲▲△
Microclimate control	▲▲▲▲△
Impact & vibration damping	▲▲▲▲△

Positioning	▲▲▲▲△
Lateral stability	▲▲▲▲△
Frontal stability	△△△△△
Sliding reduction	▲▲▲▲△
Allows manual adjustments	▲▲▲▲△
Allows easy transfers	▲▲▲▲△

Maintenance & Safety	▲▲▲▲▲
Durability	▲▲▲▲▲
Reliability	▲▲▲▲▲
Functionality when misused	▲▲▲▲△
Low maintenance level	▲▲▲▲▲
Level of hygiene	▲▲▲▲▲

Functionality & Application	▲▲▲▲△
Comfort	▲▲▲▲▲
Low cushion weight	▲▲▲▲▲
Available size range	▲▲▲▲△
Maximum user weight	▲▲▲▲▲
Low seat to floor height	n.a.
Auto adjustments	▲▲▲▲▲

USED WITH

Scoliosis, Kyphosis, Lordosis, Gibbus, pain relief

TECHNICAL SPECIFICATIONS

Length	45 cm
Average weight	350 grams
Max. user weight	150 kg
Loss of seath depth	3 cm

CUSHION SIZES

Available in 3 sizes. Mentioned cm/inches are the min-max distance between the back posts of the wheelchair.

	cm	inches
LBS/1	36-40	14¼ - 16
LBS/2	40-44	16 - 17½
LBS/3	44-48	17½ - 19

**PERFECT TO USE IN COMBINATION WITH
LIBERTY BACK AND ANATOMIC BACK**

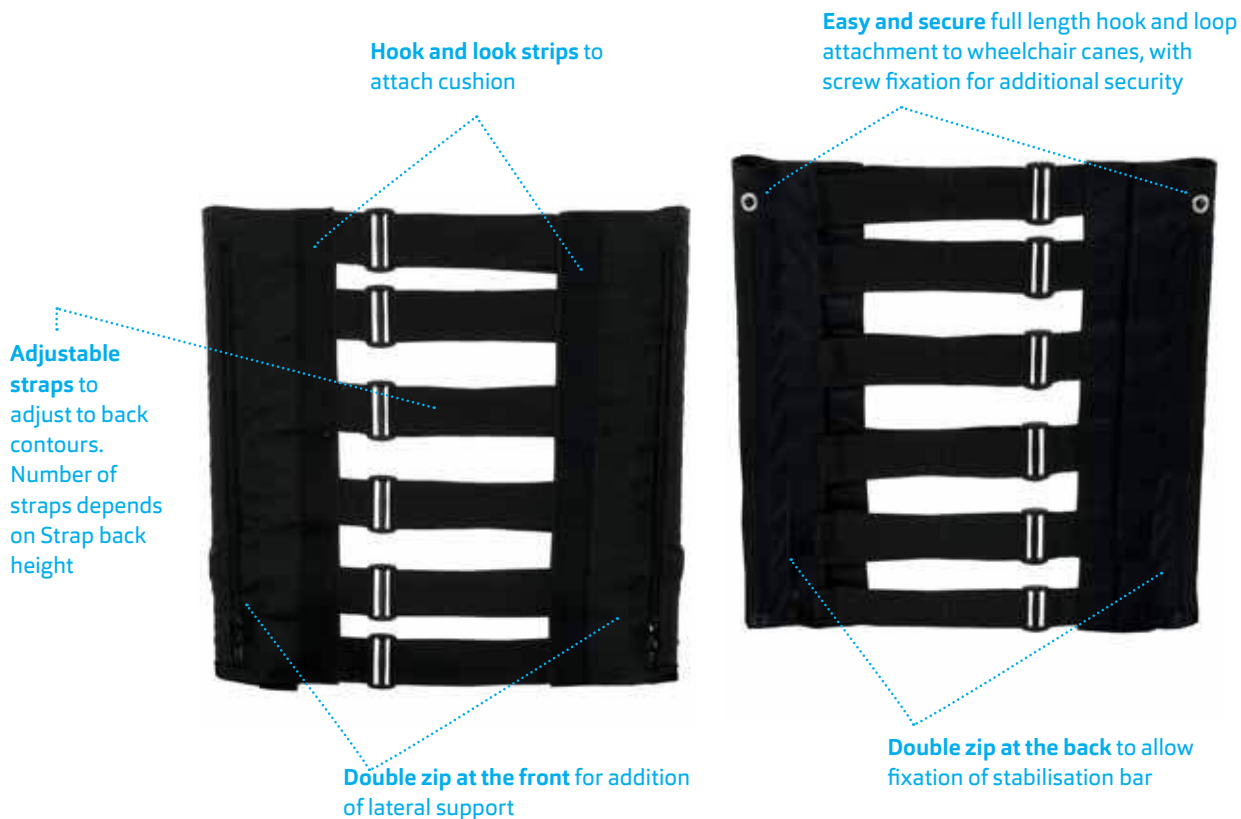

Easy to apply on manual wheelchairs

Perfect positioning and comfort qualities

Very lightweight

The Vicair Strap back is a perfect base for Vicair wheelchair back cushions. Quickly installed and combined with your choice of Vicair back cushion it is a high quality alternative to your standard wheelchair back system. The adjustable straps enhance the function of the Vicair back cushions, by offering thoracic stability and backrest positioning.

USED WITH

Vicair Liberty back, Vicair Anatomic back, Vicair Multifunctional O2 back (in combination with the Vicair Back Connector)

TECHNICAL SPECIFICATIONS

Max. user weight 150 kg

FOR OPTIMAL LYING COMFORT

Double rings on the 4 corners of the mattress, to loosely attach bedsheets to prevent "hammocking"

36 compartments with dynamic SmartCell air-filling



Combination of middle layer and low friction mattress cover to minimize shear forces and optimize immersion



**PRESSURE
ULCER
TREATMENT**

Optimal pressure redistribution

Pain relief

Extremely suitable for immobile users

Pain relief, unrest reduction, pressure ulcer prevention. These are just some examples of the immediate relief provided by the Vicair Mattress 415.

The design offers optimal pressure redistribution, reduction of shear forces, optimal immersion and stable – yet comfortable – positioning. Even with existing decubitus category I-IV (clinically proven).

If a situation requests an individual solution: custom sizes and shapes are available on request.

The Vicair Mattress 415 is low maintenance and comes with a fluid proof cover.

It can be used on any type of bedframe and bedframe position (e.g. fowler's position).

CPR can be performed on a patient without the use of a board.

The Vicair SmartCell air-filling makes the Vicair Mattress 415 an extremely lightweight and non-powered alternative to other air-technique replacement mattresses.

USED WITH

Pressure ulcers (category I-IV), rheumatism, burn victims, terminal illness, spasms, kyphosis, pain management.

TECHNICAL SPECIFICATIONS

Height	15 cm
Average weight	10 kg
Max. user weight	250 kg

MATTRESS SIZES

- Standard
- On request
- Not available

Inch	width																								
	27	28	30	32	34	36	38	40	42	44	46	48	CM	68	70	75	80	85	90	95	100	105	110	115	120
56	140																								
72	180																								
74	185																								
76	190																								
78	195																								
80	200																								
82	205																								
84	210																								
86	215																								
88	220																								



CUSTOM MADE ENDLESS POSSIBILITIES

QUALITY WARRANTY ISO



Medical practitioners often work with complex cases in the field of seating and positioning. Generally our Vicair Adjuster O2 and Vector O2 cushions are able to offer a solution, but sometimes it is necessary to provide a solution that is custom made for the client. For those situations it is possible to create a Vicair Custom Made seat- or back cushion.

Since 1993 Vicair has been creating products specifically designed for clients with complex disabilities or with specific body contours. The flexibility of the Vicair technique, based on SmartCells, makes this relatively easy to do. Our R&D team department consists of a medical doctor, a physiotherapist and a product designer.

The request for a Vicair Custom Made product is usually made by one of the product specialists of our distributors. They work closely together with the medical practitioner in the process of ordering the Vicair Custom Made product.

First the specific case is discussed in a Vicair R&D team meeting. Based on the description of the client's medical background and needs, the R&D department is able to start designing the product and creates a 3D drawing. The drawing will be discussed with the product specialist and the medical practitioner. After the design has been approved, the production of the cushion commences. Vicair has its own Product Design Studio, so within a few weeks the Vicair Custom Made product is ready to be shipped. The medical practitioner further guides the installation of the product.

Quality

Vicair is devoted to the development and production of products that will positively influence the daily comfort of the wheelchair user, to offer him or her as much freedom as possible.

We expect our products to be of very high quality, to ensure a reliable and safe result. During production all procedures and processes are performed as documented in our quality management system, in which we have implemented the applicable ISO standards and CE regulations.

Warranty

Vicair offers a limited warranty against defects in workmanship and materials for a period of 24 months (for mattresses this is 5 years) after the original date of purchase, provided the product has been used normally. Any damage arising from abnormal use, or caused by improper handling, cleaning, or negligence, is excluded from this warranty. Should a defect in materials or workmanship occur within 24 months (for mattresses this is within 5 years) from the original date of purchase, Vicair will, at its own choice, repair or replace the product free of charge. The cushion cover is excluded from this warranty. The latest generation Vicair SmartCells (grey with black logo print) have a lifelong warranty period.

Remedies for breach of express warranties herein are limited to repair or replacement of the product. In no event shall damages for breach of any warranty include any consequential damages or exceed the cost of non-conforming goods sold.

ISO certified

Vicair is ISO 13485 certified. This means it has a comprehensive quality management system for the design and manufacture of medical devices.

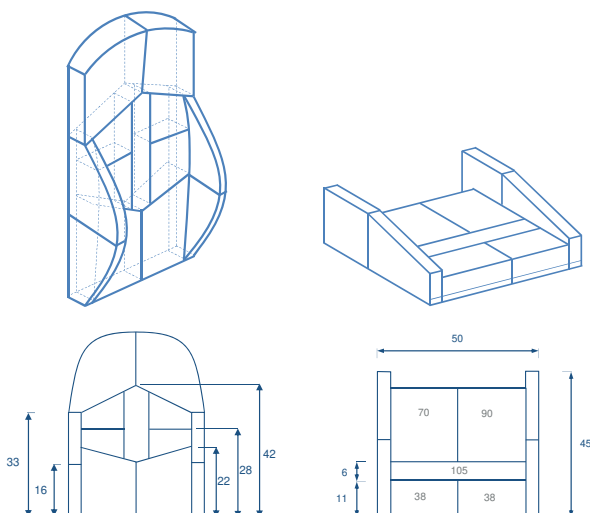

relief by air

VICAIR[®]

Bruynvisweg 5
1531 AX Wormer
The Netherlands
T + 31 (0)75 642 99 99
info@vicair.com
vicair.com

Follow us on

